

CipherLab User Guide

2200 Series Omnidirectional Presentation Barcode Scanner

Setup barcodes included.

Version 1.121



Copyright © 2018~2020 CIPHERLAB CO., LTD.
All rights reserved

The software contains proprietary information of CIPHERLAB CO., LTD.; it is provided under a license agreement containing restrictions on use and disclosure and is also protected by copyright law. Reverse engineering of the software is prohibited.

Due to continued product development this information may change without notice. The information and intellectual property contained herein is confidential between CIPHERLAB and the client and remains the exclusive property of CIPHERLAB CO., LTD. If finding any problems in the documentation, please report them to us in writing. CIPHERLAB does not warrant that this document is error-free.

No part of this publication may be reproduced, stored in a retrieval system, or transmitted in any form or by any means, electronic, mechanical, photocopying, recording or otherwise without the prior written permission of CIPHERLAB CO., LTD.

For product consultancy and technical support, please contact the local sales representative. Alternatively, visit our web site for more information.

The CipherLab logo is a registered trademark of CIPHERLAB CO., LTD.

All brand, product and service, and trademark names are the property of their registered owners.

The editorial use of these names is for identification as well as to the benefit of the owners, with no intention of infringement.

CIPHERLAB CO., LTD.

Website: <http://www.cipherlab.com>

Important Notices

For USA

This equipment has been tested and found to comply with the limits for a **Class B** digital device, pursuant to Part 15 of the FCC Rules. These limits are designed to provide reasonable protection against harmful interference in a residential installation. This equipment generates, uses and can radiate radio frequency energy and, if not installed and used in accordance with the instructions, may cause harmful interference to radio communications. However, there is no guarantee that interference will not occur in a particular installation. If this equipment does cause harmful interference to radio or television reception, which can be determined by turning the equipment off and on, the user is encouraged to try to correct the interference by one or more of the following measures:

- ▶ Reorient or relocate the receiving antenna.
- ▶ Increase the separation between the equipment and receiver.
- ▶ Connect the equipment into an outlet on a circuit different from that to which the receiver is connected.
- ▶ Consult the dealer or an experienced radio/TV technician for help.

This device complies with Part 15 of the FCC Rules. Operation is subject to the following two conditions: (1) This device may not cause harmful interference, and (2) this device must accept any interference received, including interference that may cause undesired operation.

FCC Caution: Any changes or modifications not expressly approved by the party responsible for compliance could void the user's authority to operate this equipment.

This transmitter must not be co-located or operating in conjunction with any other antenna or transmitter.

Radiation Exposure Statement:

This equipment complies with FCC radiation exposure limits set forth for an uncontrolled environment. This equipment should be installed and operated with minimum distance 20cm between the radiator & your body.

For Europe

This device complies with the essential requirements of the R&TTE Directive 1999/5/EC. The following test methods have been applied in order to prove presumption of conformity with the essential requirements of the R&TTE Directive 1999/5/EC:

- ▶ - EN 60950-1: 2006+A11:2009+A1:2010+A12:2011+A2:2013

Safety of Information Technology Equipment

- ▶ - EN 301 489-1 V2.1.1: 2016

Electromagnetic compatibility and Radio Spectrum Matters (ERM); ElectroMagnetic Compatibility (EMC) standard for radio equipment and services; Part 1: Common technical requirements

- ▶ - EN 301 489-3 V2.1.0: 2016

Electromagnetic compatibility and Radio Spectrum Matters (ERM); ElectroMagnetic Compatibility (EMC) standard for radio equipment and services; Part 3: Specific conditions for Short-Range Devices (SRD) operating on frequencies between 9 kHz and 40 GHz

- ▶ - EN 302 208-1 V3.1.1: 2016

Radio Frequency Identification Equipment operating in the band 865 MHz to 868 MHz with power levels up to 2 W and in the band 915 MHz to 921 MHz with power levels up to 4 W; Harmonised Standard covering the essential requirements of article 3.2 of the Directive 2014/53/EU

Safety Precautions

- ▶ DO NOT expose the scanner to any flammable sources.
- ▶ Under no circumstances, internal components are self-serviceable.
- ▶ For AC power adaptor, a socket outlet shall be installed near the equipment and shall be easily accessible. Make sure there is stable power supply for the scanner or its peripherals to operate properly.

Care & Maintenance

- ▶ Use a clean cloth to wipe dust off the scanning window and the body of the scanner. DO NOT use/mix any bleach or cleaner.
- ▶ If finding the scanner malfunctioning, write down the specific scenario and consult the local sales representative.

Release Notes

Version	Date	Notes
1.121	Jul. 28, 2020	<ul style="list-style-type: none">▶ Modified: Setup QR Code – QR code limited▶ New: 1.6.1 Continuous Mode▶ Modified: 3.5.5 Security Level – setting barcodes for Start/Stop characters added▶ New: 3.5.8 Quiet Zone Checking▶ Modified: 3.16.8 GS1 DataBar Security Level - default by High▶ Modified: 4.4.1 Select Pre-defined Code ID – remove parameter '1' from Han Xin symbology (AIM Code ID table)
1.12	Feb. 25, 2020	<ul style="list-style-type: none">▶ Modified: 1.8 Delay between Re-read – descriptions added relating to Light Source LEDs Behavior
1.11	Jan. 06, 2020	<ul style="list-style-type: none">▶ Modified: Symbologies Supported – GS1 DataBar Family enabled by default▶ New: 1.4.3 Bell Ring▶ Modified: 2.3.1 Activate USB HID & Select Keyboard Type – the Apple keyboard layout table & setting barcodes added▶ Modified: 3.16.2 GS1 DataBar Omnidirectional (RSS-14) – enabled by default, Transmit Code ID disabled by default▶ Modified: 3.16.3 GS1 DataBar Expanded (RSS Expanded) – enabled by default, Transmit Code ID disabled by default▶ Modified: 3.16.4 GS1 DataBar Limited (RSS Limited) - enabled by default, Transmit Code ID disabled by default▶ Modified: Appendix III Keyboard Wedge Table – 3 special keyboards
1.10	Jul. 24, 2019	<ul style="list-style-type: none">▶ Modified: 6.5 Scan Mode – Multi-Tag mode & setting barcode added▶ New: 6.5.2 Multi-Tag Timeout▶ Modified: 6.10 Output Data Format – '2' Raw Data format & setting barcode added
1.09	May 07, 2019	<ul style="list-style-type: none">▶ Modified: Reading a Barcode Label with Success (Quick Start)
1.08	Feb. 25, 2019	<ul style="list-style-type: none">▶ Modified: EAS Connection (2210 Only) – information for EAS added▶ Modified: 2.6 Direct USB OPOS - setting barcode added▶ Modified: 6.5.4 Adjustment for Output Power Level of the Reader - output power level up to 12▶ Modified: Specifications - removed Max. Power from 'UHF RFID'▶ Modified: Specifications - compatible with Checkpoint EAS deactivation systems of 8.2 MHz

- | | | |
|------|---------------|---|
| 1.07 | Jan. 24, 2019 | <ul style="list-style-type: none">▶ Modified: 2.1.1 Activate Keyboard Wedge & Select Keyboard Type - Swiss French (48), Czech (49) added▶ Modified: 2.1.6 UTF-8 Conversion - Swiss French (48), Czech (49) added▶ Modified: 2.3.1 Activate USB HID & Select Keyboard Type - Swiss French (94), Czech (95) added▶ Modified: 2.3.7 UTF-8 Conversion - Swiss French (94), Czech (95) added▶ Modified: 2.6 Direct USB OPOS – setting barcode added▶ Modified: 3.22.3 Data Matrix – ECI Information setting barcode added▶ Modified: 6.7 USB Data Output Redirection – command typo corrected▶ Modified: Appendix VI Keyboard Type One-Scan Barcode – Swiss French & Czech appended |
| 1.05 | Dec. 27, 2018 | <ul style="list-style-type: none">▶ Modified: 4.6 Multi-Barcode Editor – change to Presentation mode when enabling the editor▶ Modified: Specifications – UHF RFID frequency range includes New Zealand & Australia |
| 1.04 | Oct. 01, 2018 | <ul style="list-style-type: none">▶ Modified: 1.6.1 Presentation Mode – include object detection level & light source LED behavior▶ Modified: change section article to 4.2.1 Single Character Substitution (previous article: Select a Set for Character Substitution)▶ New: 4.2.2 Multiple Characters Substitution |

- | | | |
|------|---------------|--|
| 1.03 | Sep. 04, 2018 | <ul style="list-style-type: none"> ▶ Modified: Dual USB Connection – “USB HID” interface added to USB connector B ▶ Modified: List the Current Settings – List Page 23 appended ▶ New: 1.2.1 Continuous Decoding ▶ New: 1.3.3 Presentation LED Behavior after Decoding ▶ New: 1.14 Auto-Sense ▶ Modified: 2.1.1 Activate USB HID & Select Keyboard Type – Greek, Slovenian, Mexican Spanish, Traditional Chinese added ▶ Modified: 2.1.5 Special Keyboard Feature – “Bypass with Control Character Output for Windows” setting barcode added ▶ Modified: 2.1.6 UTF8 Conversion – Greek, Slovenian, Mexican Spanish, Traditional Chinese added ▶ Modified: 2.1.6 UTF8 Conversion – Unicode/Code Page setting barcodes added ▶ Modified: 2.3.1 Activate USB HID & Select Keyboard Type – Greek, Slovenian, Mexican Spanish, Traditional Chinese added ▶ Modified: 2.3.2 Keyboard Settings – Alt Composing added ▶ Modified: 2.3.7 UTF8 Conversion – Greek, Slovenian, Mexican Spanish, Traditional Chinese added ▶ Modified: 2.3.7 UTF8 Conversion – Unicode/Code Page setting barcodes added ▶ Modified: 2.3.8 USB Polling Interval – 4ms by default ▶ New: 2.6 Direct USB OPOS ▶ Modified: Ch. 6 – alternative setting barcodes added ▶ Modified: 6.5.3 Read/Write Tag Memory – “Write Tag Memory” parameter added ▶ Modified: 6.5.3 Read/Write Tag Memory – “RFID Written Data” function added ▶ New: 6.6 Dual Mode ▶ New: 6.7 USB Data Output Redirection (Output via connector A by default) ▶ New: 6.8 USB Connector B Interface Change ▶ New: 6.9 Output Data Sequence ▶ Modified: Appendix VI Keyboard Type One-Scan Barcode – Greek, Slovenian, Mexican Spanish, TC added |
| 1.00 | Apr. 18, 2018 | <ul style="list-style-type: none"> ▶ First Release |

Contents

- Important Notices.....- 3 -**
 - For USA..... - 3 -
 - For Europe..... - 4 -
 - Safety Precautions - 4 -
 - Care & Maintenance..... - 4 -
- Release Notes- 5 -**
- Introduction..... 1**
 - Inside the Package..... 2
 - Product Highlights 2
 - Symbologies Supported 3
- Quick Start..... 5**
 - Getting Familiarized with the Scanner 5
 - Front View 5
 - Rear View 5
 - Dimensions 6
 - Forward/Backward Angle Adjustment..... 6
 - USB Connection..... 7
 - Dual USB Connection 8
 - Connecting to 2 Hosts 9
 - Connecting to 1 Host Only 9
 - Keyboard Wedge Connection 10
 - RS-232 Connection 11
 - EAS Connection (2210 Only) 12
 - Reading a Barcode Label with Success 13
 - Configuring the Scanner 14
 - Enter Configuration Mode..... 15
 - Exit Configuration Mode..... 15
 - Default Settings 16
 - Save User Settings as Defaults..... 16
 - Restore User Defaults..... 16
 - Restore System Defaults..... 16
 - Reading a Setup Barcode 17
 - Configure Parameters..... 17
 - List the Current Settings 21
 - Creating One-Scan Setup Barcodes 23
 - 1D One-Scan Barcode 23
 - Setup QR Code..... 24

Understanding the Barcode Scanner	25
1.1 Power-On	26
1.2 Transmit Buffer.....	26
1.2.1 Continuous Decoding	26
1.3 LED Indicator.....	27
1.3.1 Good Read LED.....	27
1.3.2 Good Read LED Duration	28
1.4 Beeper.....	29
1.4.1 Beeper Volume	29
1.4.2 Good Read Beep	30
1.4.3 Bell Ring	31
1.5 Send "NR" to Host.....	32
1.6 Scan Modes.....	33
1.6.1 Continuous Mode	34
1.6.2 Presentation Mode.....	34
1.6.3 Laser Mode.....	35
1.6.4 Auto Off Mode.....	35
1.6.5 Auto Power Off Mode	36
1.6.6 Aiming Mode.....	36
1.6.7 Multi-Barcode Mode.....	37
1.7 Scanning Timeout.....	37
1.8 Delay between Re-read.....	38
1.9 Read Redundancy (1D)	39
1.10 Addon Security for UPC/EAN Barcodes.....	40
1.11 Cable Auto-Detection.....	41
1.12 Mobile Phone/Display Mode	42
1.13 2D Decode Settings.....	42
1.13.1 Aiming Pattern	42
1.13.2 Decoding Illumination	42
Selecting Output Interface	43
2.1 Keyboard Wedge.....	44
2.1.1 Activate Keyboard Wedge & Select Keyboard Type.....	45
2.1.2 Keyboard Settings.....	46
2.1.3 Inter-Character Delay.....	53
2.1.4 Inter-Function Delay	53
2.1.5 Special Keyboard Feature	54
2.1.6 UTF-8 Conversion.....	55
2.2 RS-232.....	56
2.2.1 Activate RS-232 Interface.....	56
2.2.2 Baud Rate.....	56
2.2.3 Data Bits	57
2.2.4 Parity	57
2.2.5 Stop Bit.....	57
2.2.6 Flow Control.....	58

2.2.7 Inter-Character Delay.....	59
2.2.8 Inter-Function Delay	59
2.2.9 ACK/NAK Timeout	60
2.3 Direct USB HID	61
2.3.1 Activate USB HID & Select Keyboard Type	62
2.3.2 Keyboard Settings.....	64
2.3.3 Inter-Character Delay.....	70
2.3.4 Inter-Function Delay	70
2.3.5 HID Character Transmit Mode.....	71
2.3.6 Special Keyboard Feature	71
2.3.7 UTF-8 Conversion.....	72
2.3.8 USB Polling Interval.....	73
2.4 Direct USB VCOM.....	74
2.4.1 Activate USB Virtual COM.....	74
2.4.2 Inter-Function Delay	74
2.4.3 ACK/NAK Timeout	75
2.5 Direct USB VCOM_CDC.....	76
2.5.1 Activate USB VCOM_CDC	76
2.5.2 Inter-Function Delay	76
2.5.3 ACK/NAK Timeout	77
2.6 Direct USB OPOS	78
Changing Symbology Settings.....	79
3.1 Codabar	80
3.1.1 Security Level	80
3.1.2 Start/Stop Transmission	80
3.1.3 Start/Stop Character Selection	81
3.1.4 CLSI Conversion.....	81
3.1.5 Code Length Qualification	82
3.2 Code 25 – Industrial 25	83
3.2.1 Select Start/Stop Pattern	83
3.2.2 Verify Check Digit.....	83
3.2.3 Transmit Check Digit.....	84
3.2.4 Code Length Qualification	84
3.3 Code 25 – Interleaved 25.....	86
3.3.1 Select Start/Stop Pattern	86
3.3.2 Verify Check Digit.....	86
3.3.3 Transmit Check Digit.....	87
3.3.4 Code Length Qualification	87
3.4 Code 25 – Matrix 25.....	89
3.4.1 Select Start/Stop Pattern	89
3.4.2 Verify Check Digit.....	89
3.4.3 Transmit Check Digit.....	90
3.4.4 Code Length Qualification	91
3.5 Code 39	92
3.5.1 Transmit Start/Stop Characters.....	92
3.5.2 Verify Check Digit.....	92

3.5.3 Transmit Check Digit.....	93
3.5.4 Standard/Full ASCII Code 39.....	93
3.5.5 Security Level	93
3.5.6 Asterisks (*) as data Characters.....	94
3.5.7 Code Length Qualification	94
3.5.8 Quiet Zone Checking.....	95
3.6 Code 93	96
3.6.1 Code Length Qualification	96
3.7 Code 128.....	97
3.7.1 Security Level	97
3.8 EAN-8.....	98
3.8.1 Convert to EAN-13.....	98
3.8.2 Transmit Check Digit.....	99
3.8.3 Conversion Format.....	99
3.9 EAN-13.....	100
3.9.1 EAN-13 Addon Modes	101
3.9.2 Convert to ISBN.....	103
3.9.3 Convert to ISSN.....	104
3.9.4 Transmit Check Digit.....	104
3.9.5 Security Level	104
3.10 GS1-128 (EAN-128).....	105
3.10.1 Transmit Code ID.....	105
3.10.2 Field Separator (GS Character).....	105
3.10.3 GS1 Formatting	106
3.10.4 Application ID Mark.....	106
3.11 ISBT 128.....	107
3.11.1 ISBT Concatenation	107
3.12 MSI	108
3.12.1 Verify Check Digit	108
3.12.2 Transmit Check Digit.....	108
3.12.3 Code Length Qualification.....	109
3.13 French Pharmacode.....	110
3.13.1 Transmit Check Digit.....	110
3.14 Italian Pharmacode	110
3.14.1 Transmit Check Digit.....	110
3.15 Plessey	111
3.15.1 Convert to UK Plessey.....	111
3.15.2 Transmit Check Digit.....	111
3.16 GS1 DataBar (RSS Family)	112
3.16.1 Select Code ID	112
3.16.2 GS1 DataBar Omnidirectional (RSS-14)	113
3.16.3 GS1 DataBar Expanded (RSS Expanded).....	114
3.16.4 GS1 DataBar Limited (RSS Limited).....	115
3.16.5 Field Separator (GS Character).....	116
3.16.6 GS1 Formatting	116
3.16.7 Application ID Mark.....	116

3.16.8 GS1 DataBar Security Level	117
3.17 Telepen.....	118
3.17.1 Telepen Output ASCII/Numeric.....	118
3.18 UPC-A.....	119
3.18.1 Convert to EAN-13	120
3.18.2 Transmit System Number.....	120
3.18.3 Transmit Check Digit	120
3.19 UPC-E.....	121
3.19.1 Select System Number	121
3.19.2 Convert to UPC-A.....	122
3.19.3 Transmit System Number.....	122
3.19.4 Transmit Check Digit	122
3.20 Code 11.....	123
3.20.1 Verify Check Digit	123
3.20.2 Transmit Check Digit	123
3.20.3 Security Level.....	124
3.20.4 Code Length Qualification	124
3.21 Composite Code.....	126
3.21.1 Composite CC-A/B.....	126
3.21.2 Composite CC-C	126
3.21.3 UPC Composite mode.....	127
3.22 2D Symbologies.....	128
3.22.1 PDF417.....	128
3.22.2 MicroPDF417	128
3.22.3 Data Matrix.....	128
3.22.4 QR Code/MicroQR	131
3.22.5 Maxicode.....	133
3.22.6 Aztec	133
3.22.7 Han Xin	134
Defining Output Format.....	135
4.1 Letter Case.....	135
4.2 Character Substitution.....	136
4.2.1 Single Character Substitution.....	137
4.2.2 Multiple Characters Substitution.....	138
4.2.3 Symbologies for Character Substitution (All 3 Sets).....	140
4.3 Prefix/Suffix Code.....	148
4.4 Code ID.....	149
4.4.1 Select Pre-defined Code ID	149
4.4.2 Change Code ID	153
4.4.3 Clear Code ID Settings.....	155
4.5 Length Code.....	156
4.6 Multi-Barcode Editor.....	162
4.6.1 Edit a Concatenation of Barcodes	163
4.6.2 Activate the Concatenation of Barcodes.....	165
4.7 Removal of Special Character.....	166

Applying Formats for Data Editing	167
5.1 Activating Editing Formats	168
5.1.1 Activate Editing Formats	168
5.1.2 Exclusive Data Editing	169
5.2 How to Configure Editing Formats	170
5.2.1 Select Format to Configure	171
5.2.2 Restore Default Format	172
5.3 Configuring Format — Define Data Criteria	173
5.3.1 Applicable Code Type	173
5.3.2 Data Length	182
5.3.3 Matching String & Location	183
5.4 Configuring Format — Define Data Field	184
5.4.1 Start Position	184
5.4.2 Field Adjustment	184
5.4.3 Total Number of Fields	185
5.4.4 Field Settings	186
5.4.5 Pause Field Setting	192
5.5 Configuring Format — Define Transmission Sequence	193
5.6 Programming Examples	195
5.6.1 Example I	195
5.6.2 Example II	196
UHF RFID	197
6.1 System Information	198
6.1.1 Save User Settings as Default	198
6.1.2 Restore User/Factory Defaults	199
6.2 Memory	200
6.3 LED Configuration	201
6.3.1 LED Status	201
6.3.2 LED Duration	201
6.4 Beeper Configuration	203
6.4.1 Volume	203
6.4.2 Frequency	203
6.4.3 Duration	204
6.5 Scan Mode	206
6.5.1 Single Mode Timeout	208
6.5.2 Multi-Tag Mode Timeout	209
6.5.3 Redundant Decoding (Continuous Mode)	210
6.5.4 Read/Write Tag Memory	212
6.5.5 Adjustment for Output Power Level of the Reader	217
6.6 Dual Mode	218
6.6.1 Dual Mode Timeout	219
6.6.2 Barcode Data Retention	220
6.7 USB Data Output Redirection	221
6.8 USB Connector B Interface Change	222

6.9 Output Data Sequence	223
6.10 Output Data Format.....	225
6.11 Format Editing for EPC.....	228
6.11.1 Data Field Sequence.....	228
6.11.2 Data Separator.....	231
6.11.3 Data Length.....	234
Specifications	237
Firmware Upgrade	241
Using RS-232	241
Using USB Virtual COM.....	243
Host Serial Commands	245
Serial Commands	245
Example.....	246
Keyboard Wedge Table	247
Special Keyboard: Bypass.....	247
Special Keyboard: Apply.....	248
Special Keyboard: Bypass with Control Character Output for Windows.....	249
Key Type & Status.....	250
Key Type.....	250
Key Status.....	250
Example.....	251
Numeral Systems	253
Decimal System	253
Hexadecimal System.....	254
ASCII Table.....	255
Reading Driver Licenses	257
License Parsing Setup.....	257
File Type.....	257
Output Sequence Setup.....	258
Separators and Fields	264
Edit Separators.....	265
Edit Fields	266
Keyboard Type One-Scan Barcode	267
Keyboard Wedge.....	267
Direct USB HID.....	272
Status code.....	275

Introduction

Equipped with a 2D barcode reader, the scanner is capable of reading 1D and 2D barcodes. The scanner is designed for desktop use with ease of installation. For particular deployment, the scanner can be integrated with other devices, like POS, to achieve systematic data collection.

This manual contains information on operating the scanner and using its features. It is better to keep one copy of the manual at hand for quick reference or maintenance purposes. To avoid any improper disposal or operation, please read the manual thoroughly before use.

Thank you for choosing CipherLab products!



Inside the Package

The items included in the package may be different, depending on order. Rich choices of output interfaces are available to enhance the total performance of the scanner. Refer to product specifications.

Save the box and packaging material for future use in case it is need to store or ship the scanner.

Product Highlights

- ▶ Small-form-factor and built tough to survive drop test
- ▶ Firmware upgradeable
- ▶ Supports most popular barcode symbologies, including GS1-128 (EAN-128), GS1 DataBar (RSS), etc.
- ▶ Supports a variety of 2D symbologies
- ▶ EAS integration
- ▶ UHF RFID tag detection
- ▶ Supports different scan modes, including Aiming Mode and Multi-Barcode Mode^{Note}
- ▶ Programmable feedback via LED indicator and beeper
- ▶ Beeping tone and duration programmable for Good Read
- ▶ Provides choices of output interfaces, including RS-232, Keyboard Wedge, and USB.
- ▶ Programmable parameters include data output format, editing format, symbologies, etc.
- ▶ Easy configuration through ScanMaster

Note: In any scan mode other than Multi-Barcode Mode, a barcode acceptable to the scanner can only contain data of 7 KB at most.



Symbologies Supported

Most of the popular barcode symbologies are supported, as listed below. Each can be individually enabled or disabled. The scanner will automatically discriminate and recognize all the symbologies that are enabled. Refer to [Chapter 3 Changing Symbology Settings](#) for details of each symbology.

Symbologies Supported: Enable/Disable		Default	
Codabar		Enabled	
Code 93		Enabled	
MSI			Disabled
Plessey			Disabled
Telepen			Disabled
Code 128	Code 128	Enabled	
	GS1-128 (EAN-128)	Enabled	
	ISBT 128	Enabled	
Code 2 of 5	Industrial 25	Enabled	
	Interleaved 25	Enabled	
	Matrix 25		Disabled
Code 3 of 9	Code 39	Enabled	
	Italian Pharmacode		Disabled
	French Pharmacode		Disabled
EAN/UPC	EAN-8	Enabled	
	EAN-8 Addon 2		Disabled
	EAN-8 Addon 5		Disabled
	EAN-13	Enabled	
	EAN-13 & UPC-A Addon 2		Disabled
	EAN-13 & UPC-A Addon 5		Disabled
	ISBN		Disabled
	UPC-E0	Enabled	
	UPC-E1		Disabled
	UPC-E Addon 2		Disabled
	UPC-E Addon 5		Disabled
	UPC-A	Enabled	
	UPC-A Addon 2		Disabled
UPC-A Addon 5		Disabled	
Code 11			Disabled



GS1 DataBar (RSS)	GS1 DataBar Omnidirectional (RSS-14)	Enabled	
	GS1 DataBar Truncated	Enabled	
	GS1 DataBar Limited (RSS Limited)	Enabled	
	GS1 DataBar Expanded (RSS Expanded)	Enabled	
Composite Code	Composite CC-A/B		Disabled
	Composite CC-C		Disabled
2D Symbologies	PDF417	Enabled	
	MicroPDF417		Disabled
	Data Matrix	Enabled	
	Maxicode	Enabled	
	QR Code/MicroQR	Enabled	
	Aztec	Enabled	
	Han Xin		Disabled



Quick Start

Getting Familiarized with the Scanner

Front View

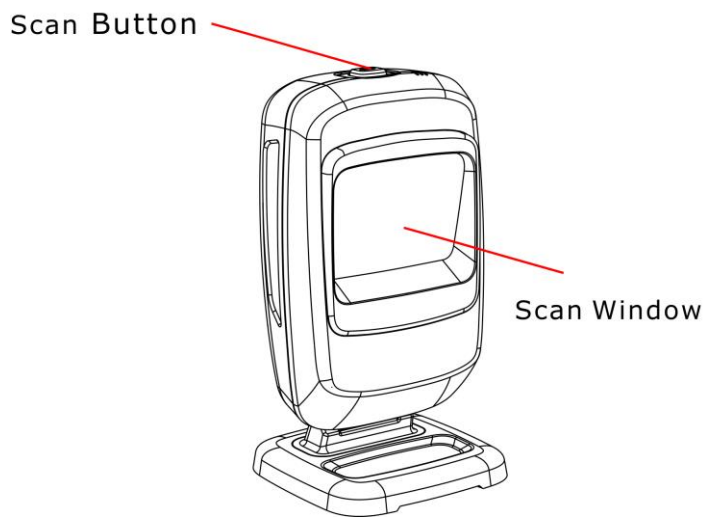

Rear View

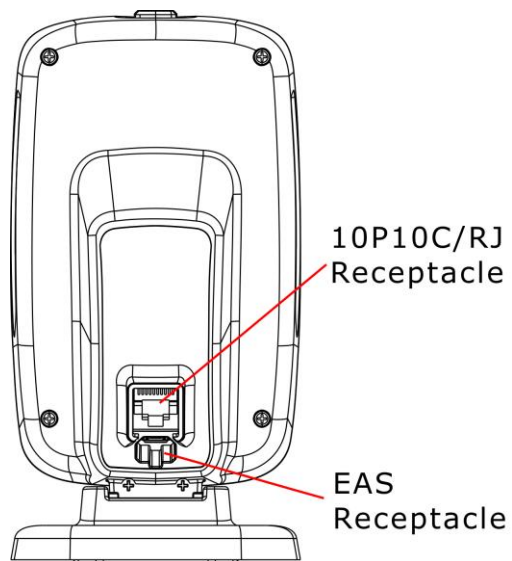

Dimensions

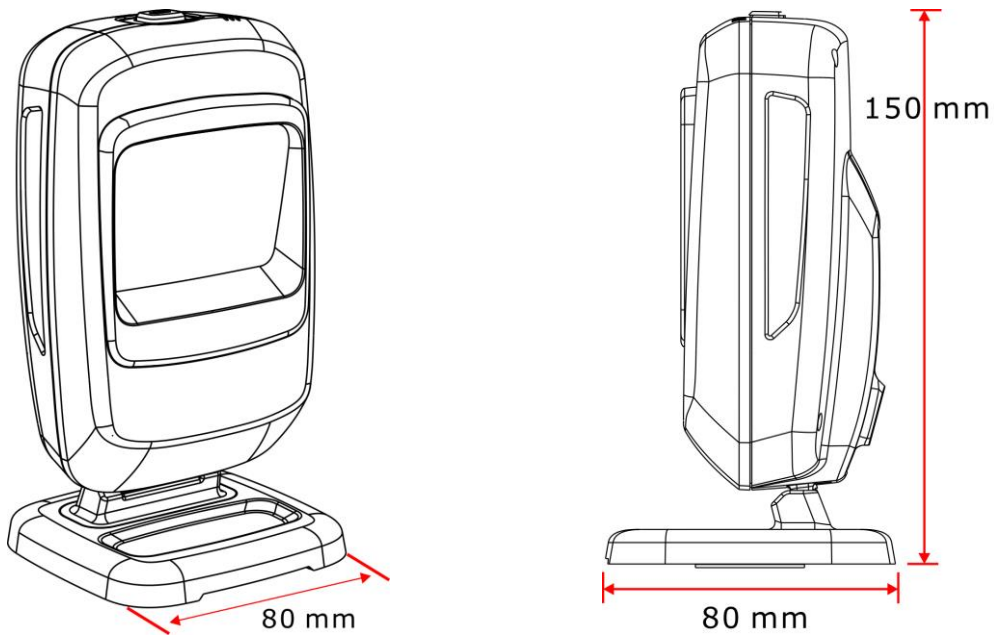

Forward/Backward Angle Adjustment

Tilt the barcode scanner forward up to 40 degrees or backward up to 15 degrees to adjust the angle best suited for scanning.

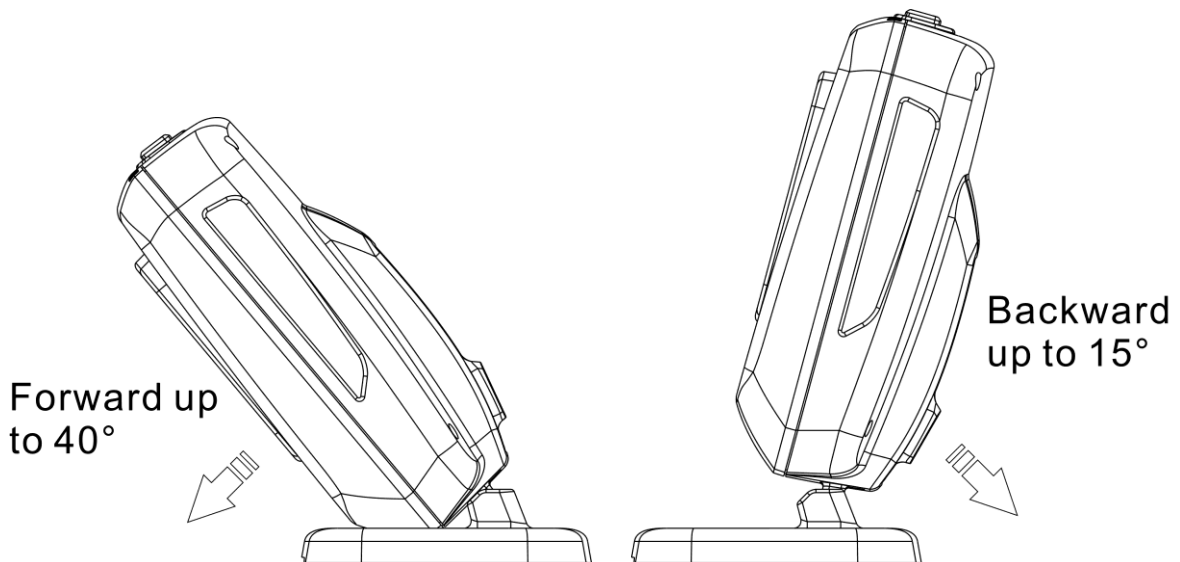

USB Connection

Connect the USB cable between the scanner and the host computer.

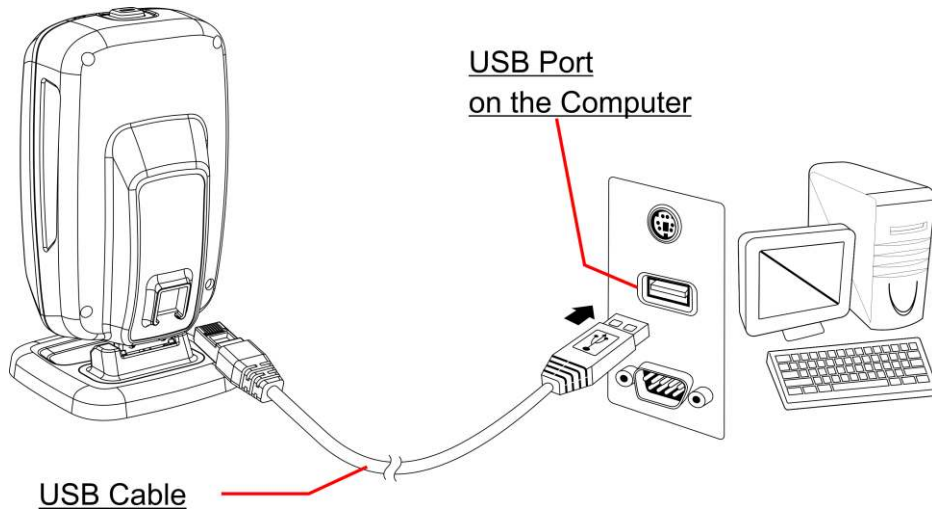

Dual USB Connection

Connector A: Barcode Data Transmission and System Configuration (ScanMaster tool) via USB HID/VCOM/VCOM_CDC

Connector B: UHF RFID Data Transmission and UHF RFID Serial Commands via USB VCOM_CDC or USB HID

Connector	A	B
Interface	<ul style="list-style-type: none"> ▶ USB HID ▶ USB VCOM ▶ USB VCOM CDC 	<ul style="list-style-type: none"> ▶ USB VCOM CDC ▶ USB HID
Output Barcode Data	O	X
Output UHF RFID Tag Data	O	O
Input Host Serial Command	O	X
Input UHF RFID Serial Command	O	O
ScanMaster Configuration	O	X
Firmware Upgrade	O	X



Connecting to 2 Hosts

Connect the Dual USB cable between the scanner and two host computers which are both turned on.

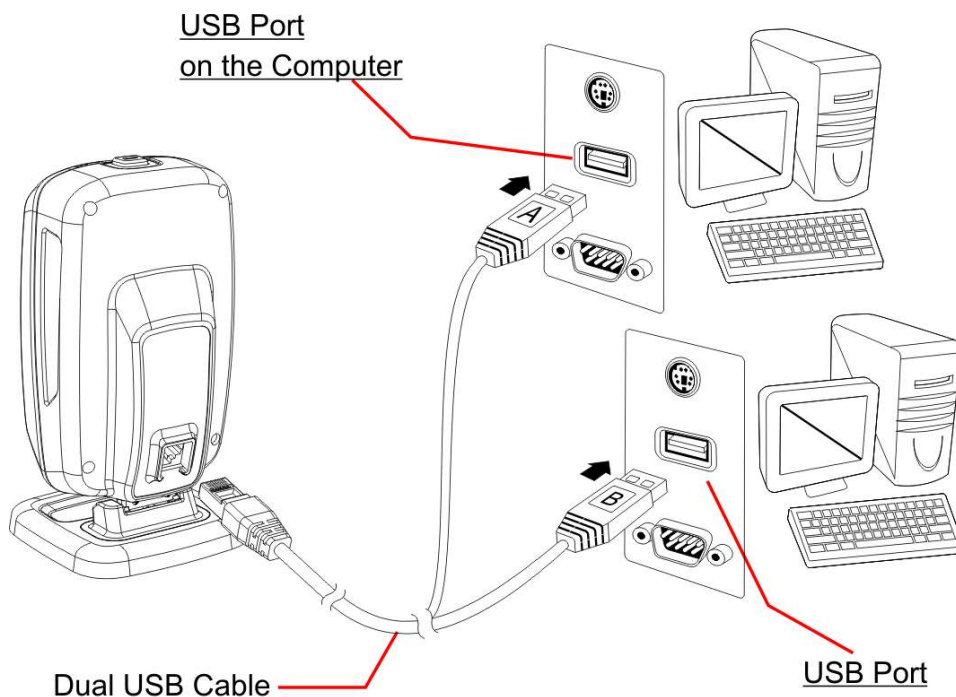

Connecting to 1 Host Only

The dual USB connectors are attached to USB ports of a single host computer.

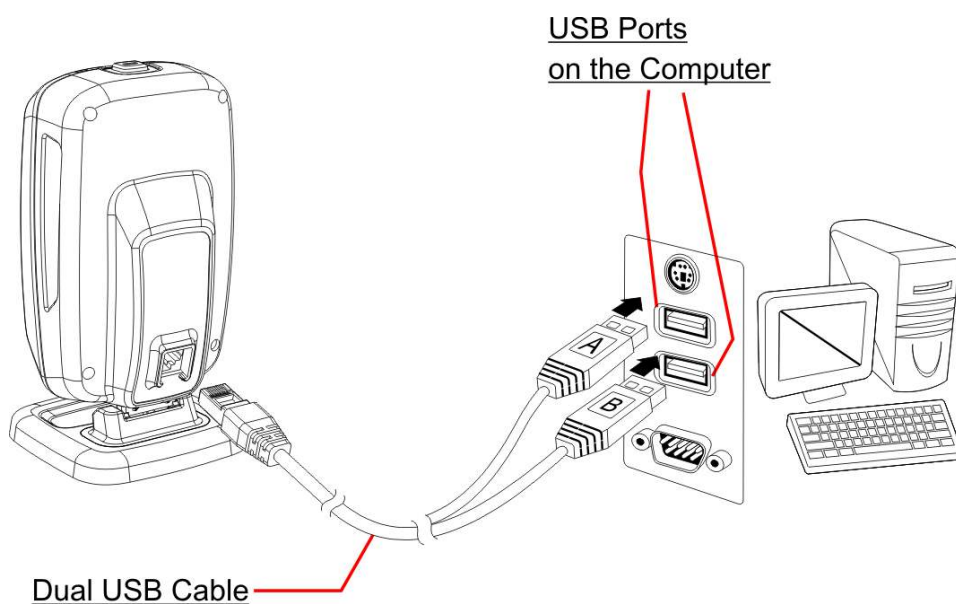

Keyboard Wedge Connection

1. Power off the host computer.
2. Disconnect the PS/2 keyboard from the host computer.
3. Attach the PS/2 Male connector to the PS/2 port on the computer.
4. Attach the PS/2 Female connector to the PS/2 keyboard.
5. Power on the host computer.

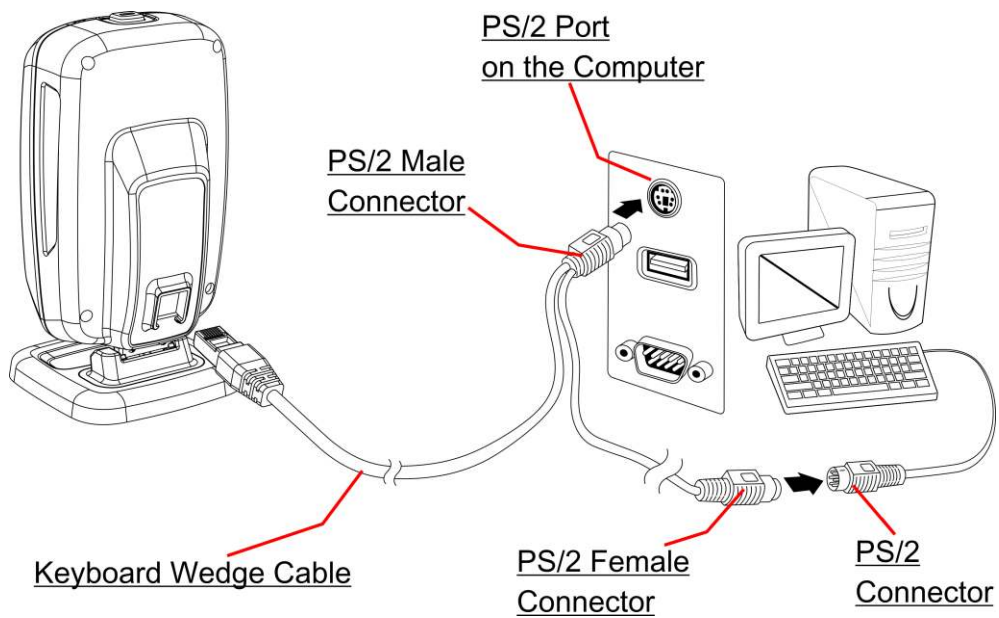

RS-232 Connection

1. Connect the RS-232 cable between the scanner and the host computer.
2. Fasten the side screws to secure the DB-9 connector.
3. Plug the power adapter into a power outlet nearby.

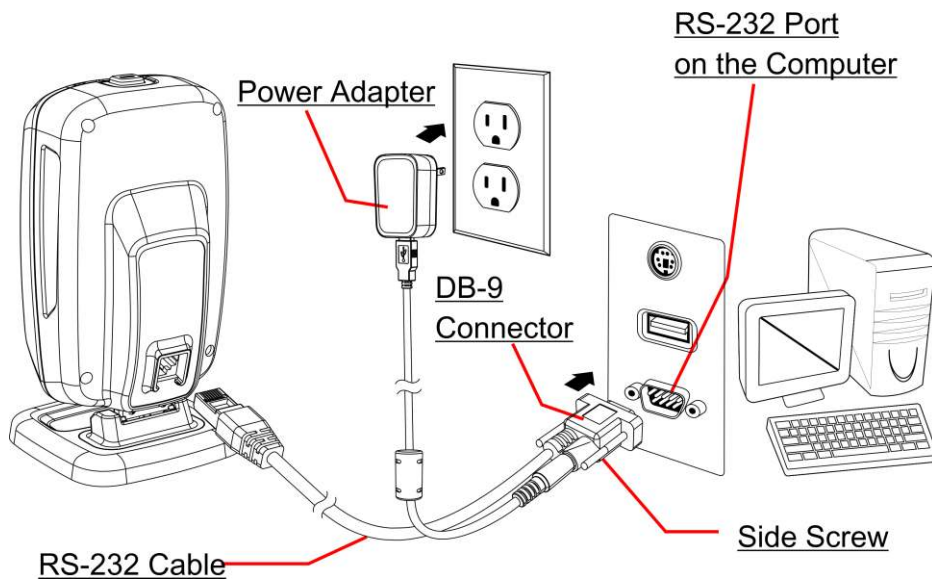

EAS Connection (2210 Only)

The 2210 scanner equipped with EAS is an optional solution. Attach the included EAS cable between the scanner and the EAS device.

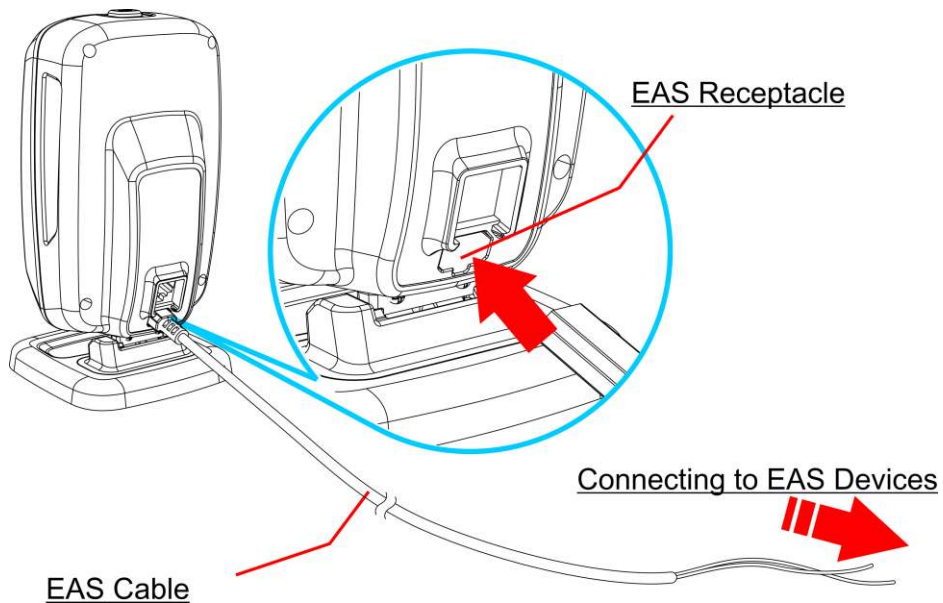

2210 includes an integrated RF antenna, which is compatible with RF type 8.2Mhz frequency EAS deactivation system.

The reading range must be adjusted by EAS system. Please contact your EAS deactivation system representative to insure proper operations.

Note:

Do not store EAS tags within 50 cm of the 2210. Tags stored closer than 50 cm may be unintentionally deactivated, including the area behind and under 2210. Do not put any large metal material near 2210, or it may interfere with the deactivation field.



Reading a Barcode Label with Success

As the picture illustrated below, bring the target barcode label within the reading area so that the scanner will be able to decode it with success.

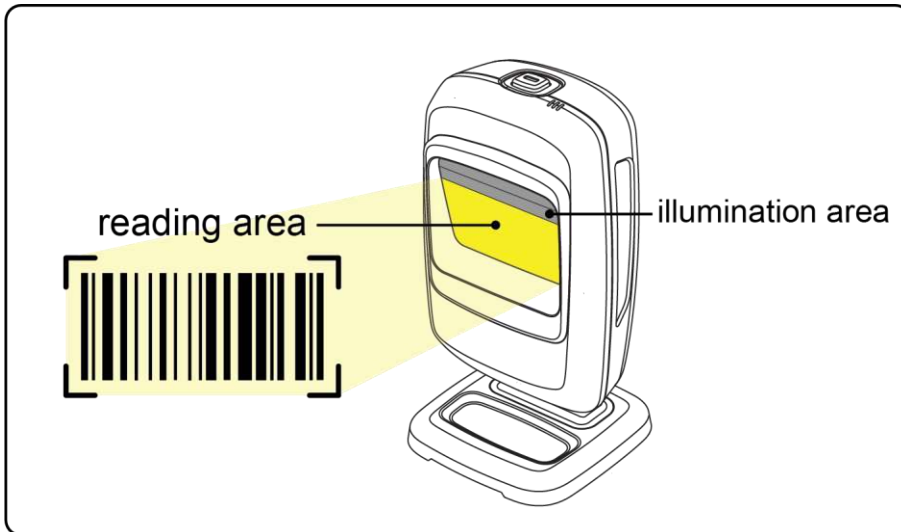

Configuring the Scanner

The configuration of the scanner can be done by reading the setup barcodes (setup labels) contained in this manual or via the *ScanMaster* software.

This section describes the procedure of configuring the scanner by reading the setup barcodes and provides some examples for demonstration.

Note: If RS-232 or USB Virtual COM is selected for output interface, the host can directly send serial commands to configure the scanner.
For example, run HyperTerminal.exe and type the 6-digit command located under each setup barcode. Refer to [Appendix II Host Serial Commands](#).

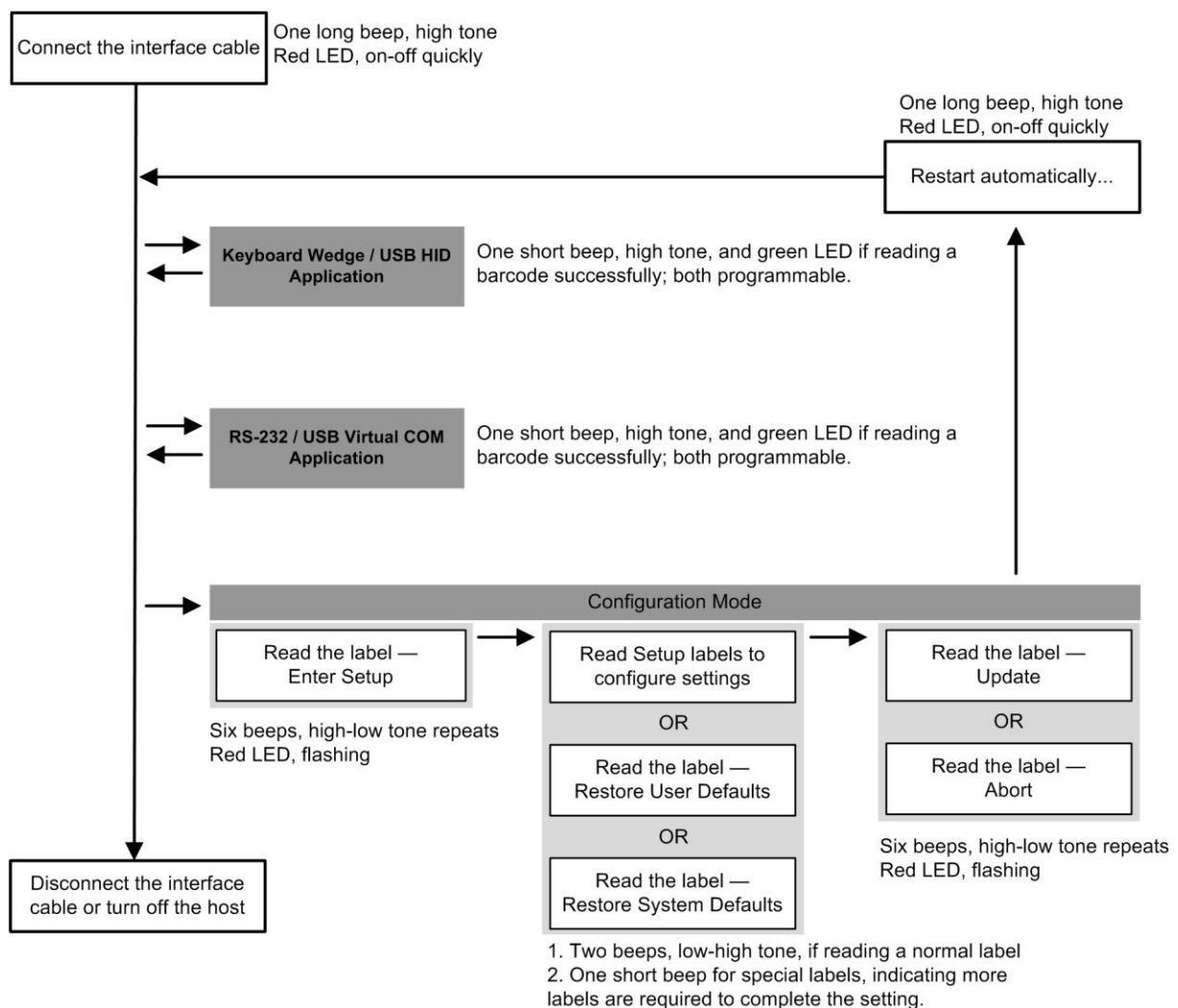

Enter Configuration Mode

For the scanner to enter the configuration mode, have it read the "Enter Setup" barcode located at the bottom of almost every even page of this manual.

- ▶ The scanner will respond with six beeps and its LED indicator will become flashing red after reading the barcode.

Enter Setup



For configuring scanner parameters, see "Read a Setup Barcode" below.

Exit Configuration Mode

For the scanner to save settings and exit the configuration mode, have it read the "Update" barcode located at the bottom of almost every odd page of this manual. To exit the configuration mode without saving any changes, have the scanner read the "Abort" barcode instead.

- ▶ Just like reading the "Enter Setup" barcode, the scanner will respond with six beeps and its LED indicator will become flashing red after reading the barcode. Wait for a few seconds for the scanner to restart itself.

Update



109999

Abort



109998



Update

Default Settings

Save User Settings as Defaults

For the scanner to keep the customized settings as user defaults, have it read the "Save as User Defaults" barcode. This is a normal setup barcode, and the scanner will respond with two beeps (low-high tone).

- ▶ After reading the "Update" barcode, the current settings (including RFID settings) will be saved as user defaults.

Save as User
Defaults



Restore User Defaults

For the scanner to restore the user defaults saved earlier, have it read the "Restore User Defaults" barcode. This is a normal setup barcode, and the scanner will respond with two beeps (low-high tone).

- ▶ After reading the "Update" barcode, all the parameters of the scanner will return to their customized values (including RFID settings).

Restore User
Defaults



Restore System Defaults

For the scanner to restore the factory defaults, have it read the "Restore System Defaults" barcode. This is a normal setup barcode, and the scanner will respond with two beeps (low-high tone).

- ▶ After reading the "Update" barcode, all the parameters of the scanner will return to their default values (including RFID settings).

Restore System
Defaults



Note: The system default value (if there is) for each setting is indicated by an asterisk "*".



Reading a Setup Barcode

Configure Parameters

For most of the scanner parameters, only one read is required to set them to new values. The scanner will respond with two beeps (low-high tone) when each parameter is set successfully.



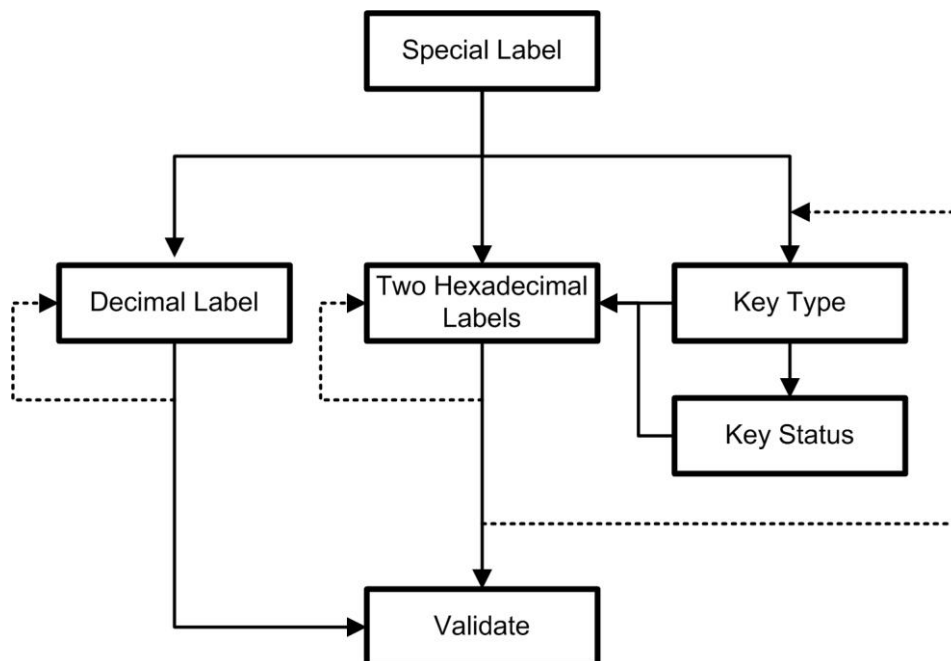

But for a number of special parameters, multiple reads are required to complete the setting. In this case, the scanner will respond with a short beep indicating it needs to read more setup barcodes. These special parameters may require reading one or more setup barcodes, such as

- ▶ Numeric barcodes, say, for keyboard type, inter-character delay, length qualification
- ▶ Hexadecimal barcodes, say, for character strings as prefix, suffix, etc.
- ▶ When "Keyboard Wedge" or "USB HID" is configured as the interface, Key Type and Key Status will then become applicable. Decide whether or not to change key status when "Normal Key" is selected for Key Type.

To complete the configuration of these special parameters, it requires reading the "Validate" barcode, and then the scanner will respond with two beeps (low-high tone) to indicate the input values are validated.









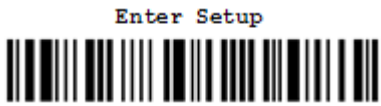

The example below shows how to save settings as “User Default” to restore user defaults later:

Steps	Action	Scanner Feedback if Successful
1	Power on the scanner...	The scanner will respond with a long beep (high tone) and its LED indicator will become solid red and go off quickly.
2	Enter the Configuration Mode...	The scanner will respond with six beeps (high-low tone repeats three times), and its LED indicator will be flashing red.
3	Read a Setup barcode... For example,	The scanner will respond with two beeps (low-high tone) if reading a normal setup barcode.
<p style="text-align: center;">Enter Setup</p>  <p style="text-align: center;">*Enable Industrial 25</p>  <p style="text-align: center;">100307</p> <p style="text-align: center;">Save as User Default</p>  <p style="text-align: center;">109986</p>		
4	Exit the Configuration Mode...	Same as for <i>Enter the Configuration Mode</i> .
<p style="text-align: center;">Update Abort</p>  <p style="text-align: center;">109999 OR 109998</p>		
5	The scanner will automatically restart itself...	Same as for <i>Power on the scanner</i> .
*	When any configuration error occurs...	The scanner will respond with one long beep (low tone).







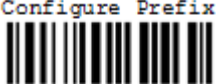

The example below shows how to set numeric parameters:

Steps	Action	Scanner Feedback if Successful
1	Power on the scanner...	The scanner will respond with a long beep (high tone) and its LED indicator will become solid red and go off quickly.
2	Enter the Configuration Mode... 	The scanner will respond with six beeps (high-low tone repeats three times), and its LED indicator will become flashing red.
3	Read a Setup barcode... For example,	The scanner will respond with two beeps (low-high tone) if reading a normal setup barcode.
	<div style="border: 1px solid red; padding: 2px; display: inline-block;">Normal setup barcode</div> 	
	<div style="border: 1px solid red; padding: 2px; display: inline-block;">Normal setup barcode</div> 	
	<div style="border: 1px solid red; padding: 2px; display: inline-block;">Special setup barcode</div> 	The scanner will respond with one short beep if reading a special setup barcode such as "Max. Length", indicating the setup requires reading more barcodes.
	<div style="border: 1px solid red; padding: 2px; display: inline-block;">Decimal barcodes</div>   	<p>Read the "Decimal Value" barcode(s).</p> <ul style="list-style-type: none"> ▶ Refer to Appendix IV "Decimal System"
4	Exit the Configuration Mode...  OR 	Same as for <i>Enter the Configuration Mode</i> .
5	The scanner will automatically restart itself...	Same as for <i>Power on the scanner</i> .

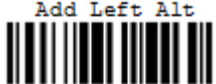

The example below shows how to set string parameters:

Steps	Action	Scanner Feedback if Successful
1	Power on the scanner...	The scanner will respond with a long beep (high tone) and its LED indicator will become solid red and go off quickly.
2	Enter the Configuration Mode...	The scanner will respond with six beeps (high-low tone repeats three times), and its LED indicator will become flashing red.
3	Read a Setup barcode... For example,	The scanner will respond with one short beep if reading a special setup barcode such as "Prefix Code", indicating the setup requires reading more barcodes.
<div style="border: 1px solid red; padding: 2px; display: inline-block;">Special setup barcodes</div>	<p style="text-align: center;">Configure Prefix</p>  <p style="text-align: center;">101230</p>	<p>When "Keyboard Wedge" or "USB HID" is configured for interface, Key Type and Key Status will then become applicable. Decide whether or not to change key status when "Normal Key" is selected for Key Type.</p> <p>▶ Refer to Appendix III</p>
	<p style="text-align: center;">*Normal</p>  <p style="text-align: center;">109926</p>	
	<p style="text-align: center;">Add Left Alt</p>  <p style="text-align: center;">109932</p>	
<div style="border: 1px solid red; padding: 2px; display: inline-block;">Hexadecimal barcodes</div>	<p style="text-align: center;">2</p>  <p style="text-align: center;">109902</p>	<p>Read the "Hexadecimal Value" barcodes for the desired character string. For example, read "2" and "B" for the scanner to prefix the character "+".</p> <p>▶ Refer to Appendix IV "Hexadecimal System"</p>
	<p style="text-align: center;">B</p>  <p style="text-align: center;">109911</p>	
	<p style="text-align: center;">Validate</p>  <p style="text-align: center;">109994</p>	
4	Exit the Configuration Mode...	Same as for <i>Enter the Configuration Mode</i> .
5	The scanner will automatically restart itself...	Same as for <i>Power on the scanner</i> .



List the Current Settings

The current settings of all scanner parameters can be sent to the host computer for user inspection. The listing includes pages as shown below. Select the page of interest by having the scanner read the "List Page x" barcode. The scanner will respond with two beeps (low-high tone) and send the selected page to the host immediately.

Lists settings regarding Firmware Version, Serial Number, Interface, Buzzer, and Other Scanner Parameters

List Page 1



109950

Lists settings regarding Prefix, Suffix, and Length Code Setting (1/2)

List Page 2



109951

Lists settings regarding Prefix, Suffix, and Length Code Setting (2/2)

List Page 3



109952

Lists settings regarding Code ID

List Page 4



109953

Lists settings regarding: Readable Symbologies (1/2)

List Page 5



109954

Lists settings regarding: Readable Symbologies (2/2)

List Page 6



109955

Lists settings regarding Symbology Parameters (1/3)

List Page 7



109956

Lists settings regarding Symbology Parameters (2/3)

List Page 8



109957

Lists settings regarding Symbology Parameters (3/3)

List Page 9



109958

Reserved

List Page 10



109959



Lists settings regarding Editing Format 1
(1/2)

List Page 11



Lists settings regarding Editing Format 1
(2/2)

List Page 12



Lists settings regarding Editing Format 2
(1/2)

List Page 13



Lists settings regarding Editing Format 2
(2/2)

List Page 14



Lists settings regarding Editing Format 3
(1/2)

List Page 15



Lists settings regarding Editing Format 3
(2/2)

List Page 16



Lists settings regarding Editing Format 4
(1/2)

List Page 17



Lists settings regarding Editing Format 4
(2/2)

List Page 18



Lists settings regarding Editing Format 5
(1/2)

List Page 19



Lists settings regarding Editing Format 5
(2/2)

List Page 20



Lists settings of Driver License parsing

List Page 22



Lists RFID settings

List Page 23



Creating One-Scan Setup Barcodes

Most of the scanner parameters require only one read for setting new values. To facilitate configuring the scanner, create One-Scan setup barcodes for use.

1D One-Scan Barcode

The requirements of a One-Scan setup barcode are:

- ▶ a prefix of the “#@” characters
- ▶ the six digits of command parameters
- ▶ a suffix of the “#” character

For example, the scanner needs reading three setup barcodes for the command parameter “109952” to take effect:

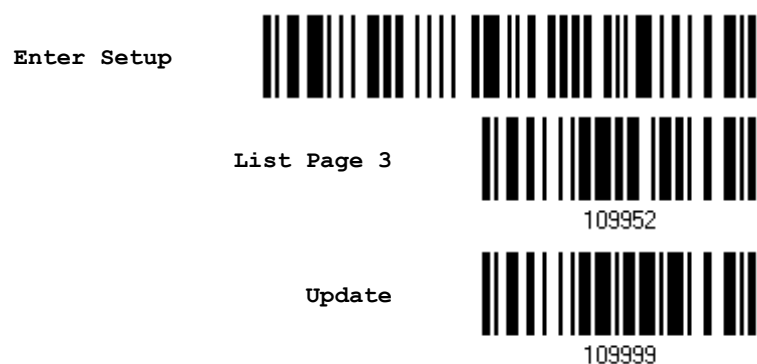

Now, it requires only one read:



Note: The scanner will restart automatically upon reading the One-Scan setup barcode for changing the interface. It will respond with a long beep and its LED will come on-off shortly.



Setup QR Code

Users can also scan a single QR code combining with a series of serial commands to configure the scanner. For example, if you want to change the suffix character to `#`, you will need to input the serial commands in sequence as follows (underlining the digits is to make them more readable):

#@CipherLab101231109902109903109994

Command	Purpose
#@CipherLab	Enter Setup
101231	Configure suffix
109902	Give the first hexadecimal digit of 0x23
109903	Give the second hexadecimal digit of 0x23 for taking `#` as the suffix
109994	Validate the settings

The serial commands above can be combined to form a setup QR code:

Setup QR Code for configuring suffix

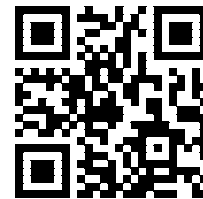

Understanding the Barcode Scanner

This chapter explains the features and usage of the barcode scanner.

In This Chapter

1.1 Power-On.....	26
1.2 Transmit Buffer.....	26
1.3 LED Indicator	27
1.4 Beeper.....	29
1.5 Send "NR" to Host.....	32
1.6 Scan Modes.....	33
1.7 Scanning Timeout	37
1.8 Delay between Re-read.....	38
1.9 Read Redundancy (1D).....	39
1.10 Addon Security for UPC/EAN Barcodes	40
1.11 Cable Auto-Detect	41
1.12 Mobile Phone/Display Mode	42
1.13 2D Decode Settings	42



1.1 Power-On

Connect the interface cable between the scanner and computer.

- ▶ When using the RS-232 cable, attach the accompanying power adaptor to power up the scanner.
- ▶ The scanner will respond with one long beep (high tone) and its LED indicator will become solid red and go off quickly.

1.2 Transmit Buffer

The scanner is designed to send any collected data to a host computer one by one via the transmit buffer (SRAM). Upon reading a barcode successfully, the scanner responds with one short beep (high tone) and its LED indicator becomes solid green and goes off quickly.

The host computer may not receive the data immediately if using a low baud rate or waiting for handshake signal (flow control). With the 10 KB transmit buffer, the scanner can ignore the transmission status and keep on reading barcodes until the buffer is full. A warning is given when the transmit buffer is full — the scanner will respond with one long beep (low tone) and its LED indicator will become solid red and go off quickly.

Note: The 10 KB transmit buffer on the scanner can hold as many as 640 scans based on EAN-13 barcodes. Data will be cleared out once the power adaptor to the RS-232 cable is removed or other interface cable is disconnected!

By default the transmit buffer is enabled. Users can decide whether to use the transmit buffer function by reading the Enable/Disable barcode below.



1.2.1 Continuous Decoding

The scanner only proceeds with the next decode after the host computer has successfully received data. In case of transmitting a huge mass of 2D barcode data, users may encounter difficulties in keeping decoding barcodes. Enabling this function can have the scanner keep decoding without waiting for the host to complete the data receiving.





1.3 LED Indicator

The Tri-color LED on top of the scanner indicates operating status. For example, the LED becomes solid red and goes off quickly upon powering on or running out of transmit buffer. Users can tell the difference by the beeps.

Scanner LED			Meaning
Red, on-off		---	<ul style="list-style-type: none"> ▶ Power on, with one long beep (high tone, LED on for 1 second) ▶ Transmit buffer full, with one long beep (low tone) ▶ RS-232/USB Virtual COM connection fails, with two beeps (high-low tone)
---		Green, on-off	Good Read, with one short beep (high tone); beeper pitch and duration programmable
Red, flashing		---	Configuration Mode (On/Off ratio 0.5 s: 0.5 s)
	Blue, on-off		Good Read for RFID, with one short beep (high tone); beeper pitch and duration programmable

1.3.1 Good Read LED

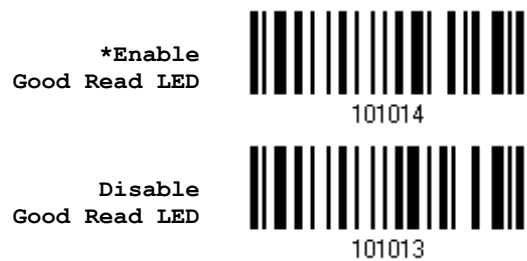

1.3.2 Good Read LED Duration

By default, the Good Read LED stays on for 40 milliseconds. Specify a value, ranging from 1 to 254 in units of 10 milliseconds.

Good Read LED
Time-out after
0.01~2.54 sec.
(*40 ms)



- 1) Read the barcode above to specify the time interval before the Good Read LED goes off.
- 2) Read the "[Decimal Value](#)" barcode on page 253. For example, read "1" and "5" for the LED to go off after 150 milliseconds.
- 3) Read the "Validate" barcode on the same page to complete this setting.







1.4 Beeper

The scanner has a buzzer to give feedback for various operating conditions.

Beeping	Meaning
One long beep, high tone	Power on, with red LED on (1 second) and off quickly
One short beep, high tone ▶ Programmable, default to 4 KHz	Good Read, with green (blue for RFID) LED on-off quickly
Six short beeps ▶ High-low tone repeats three times	▶ Enter Configuration Mode, with red LED flashing ▶ Exit Configuration Mode
Two beeps, low-high tone	▶ Setup barcode read successfully
Two beeps, high-low tone	RS-232/USB Virtual COM connection fails (data saved in Transmit Buffer), with red LED on-off quickly
One short beep, high tone	More setup barcode required
One short beep, low tone	More barcodes required to complete the "output sequence" requirements of Multi-Barcode Editor, with green LED on-off quickly (Upon completion, same as Good Read.)
One long beep, low tone	▶ Transmit buffer full, with red LED on-off quickly ▶ Configuration error (Wrong barcode...)
Two long beeps, high-low tone	Multi-Barcode Mode – Buffer full

1.4.1 Beeper Volume

Scanning these barcodes will change beeper volume for both barcode and UHF RFID tag reading.

Mute	
	101009
Minimum Volume	
	101010
Medium Volume	
	101011
*Maximum Volume	
	101012







1.4.2 Good Read Beep

Frequency

8 kHz	 101001
4 kHz	 101002
*2 kHz	 101003
1 kHz	 101004

Duration

*Shortest	 101005
Shorter	 101006
Longer	 101007
Longest	 101008



1.4.3 Bell Ring

With this function enabled, the scanner will produce a bell ring when receiving the '0x07' character which is sent via the RS-232, VCOM, and VCOM CDC interface.



1.5 Send "NR" to Host

This feature only works when Keyboard Wedge or RS-232 is selected for output interface. Have the scanner send the "NR" string to the host to notify the No Read event.

Enable



100267

*Disable



100266



1.6 Scan Modes

Different scan modes are supported – select the scan mode that best suits the requirements of a specific application. Refer to the comparison table below.

- ▶ In any scan mode other than Multi-Barcode Mode, a barcode acceptable to the scanner can only contain data of 7 KB at most.

Scan Mode	Start to Scan				Stop Scanning			
	Always	Press scan button once	Hold scan button	Press scan button twice	Release scan button	Press scan button once	Barcode being read	Timeout
Continuous mode	✓							
Presentation mode	✓		*		*			
Laser mode			✓		✓		✓	✓
Auto Off mode		✓					✓	✓
Auto Power Off mode		✓						✓
Aiming mode				✓			✓	✓
Multi-Barcode mode			✓		✓			

Note: By default, the scan mode is set to Presentation mode.

- * In Presentation mode, you can press the scan button to force the scanner into Laser mode. Two seconds after you release the scan button, the scanner automatically gets back into Presentation mode.



1.6.1 Continuous Mode

The scanner is always scanning.

- ▶ After a successful decoding, the removal of barcode is required. It is not allowed to proceed to decode until the decoding delay time has passed.
- ▶ To decode the same barcode repeatedly, move away the barcode and put it back again and again for scanning.

Note: Refer to [1.8 Delay between Re-read](#).

Continuous Mode



100201

1.6.2 Presentation Mode

The scanner will be expecting barcodes in *Presentation* mode. Whenever a barcode is brought within range, the scanner will be able to decode it.

In *Presentation* mode, you can press the scan button to force the scanner into *Laser* mode. Two seconds after you release the scan button, the scanner automatically gets back into *Presentation* mode.

*Presentation Mode



100210

Object Detection Level

Users can determine the object detection level ranging from 0 to 7 (default value is set to 4; greater number means higher detection sensitivity).

Object Detection
Level 0~7 (*4)



101483

- 1) Read the barcode above to specify the Object Detection level.
- 2) Read the "[Decimal Value](#)" barcode on page 253. For example, read "1" to set the Object Detection Level on 1.
- 3) Read the "Validate" barcode on the same page to complete this setting.



Light Source LEDs Behavior

Users can change the light source LEDs behaviour. When set to ON, the light source LEDs will last for a longer time after decoding.



1.6.3 Laser Mode

The scanner will start scanning once the scan button is pressed.

- ▶ The scanning won't stop until (1) a barcode is decoded, (2) the pre-set timeout expires, or (3) release the scan button.

Note: Refer to [1.7 Scanning Timeout](#).



1.6.4 Auto Off Mode

The scanner will start scanning once the scan button is pressed.

- ▶ The scanning won't stop until (1) a barcode is decoded, and (2) the pre-set timeout expires.

Note: Refer to [1.7 Scanning Timeout](#).



1.6.5 Auto Power Off Mode

The scanner will start scanning once the scan button is pressed.

- ▶ The scanning won't stop until the pre-set timeout expires, and, the pre-set timeout period re-counts after each successful decoding.

Note: Refer to [1.8 Delay between Re-read](#) and [1.7 Scanning Timeout](#).

Auto Power Off Mode



1.6.6 Aiming Mode

The scanner will aim at a barcode once the scan button is pressed, and start scanning when the scan button is pressed again within one second.

- ▶ The scanning won't stop until (1) a barcode is decoded, and (2) the pre-set timeout expires.

Aiming Mode



Aiming Timeout

Limit the aiming time interval (1~15). By default, the scanner time-out is set to 1 second.

Aiming Time-out
after 1~15 sec.
(*1)



1. Read the barcode above to specify the time interval before aiming ends. (It is set to 1 by default.)
2. Read the "[Decimal Value](#)" barcode on page 253. For example, read "1" and "0" for the scanner to automatically shut down after being idle for 10 seconds.
3. Read the "Validate" barcode on the same page to complete this setting.



1.6.7 Multi-Barcode Mode

The scanner will be scanning as long as the scan button is pressed, capable of decoding one single barcode, as well as multiple unique barcodes one at a time. While decoding a bunch of unique barcodes, if a barcode is decoded twice, its subsequent decoding will be ignored and the scanner is expecting another unique barcode.

For multiple unique barcodes, the maximum output data length of all the barcodes is 10 KB after configuration. When the output length exceeds 10 KB, Multi-Barcode Mode will not take effect.

- ▶ The scanning won't stop until you release the scan button.

Multi-Barcode Mode



Note: (1) A barcode is considered unique when its Code Type or data is different from others.
 (2) Multi-Barcode Mode has nothing to do with the [4.6 Multi-Barcode Editor](#).

1.7 Scanning Timeout

Specify the scanning time interval (1~254 sec.; 0= Disable) when the scan mode is set to any of the following –

- ▶ Laser mode
- ▶ Auto Off mode
- ▶ Auto Power Off mode
- ▶ Aiming mode

Scanner Time-out
after 0~254 sec.
(*10)



- 1) Read the barcode above to specify the time interval before the scan engine times out.
- 2) Read the "[Decimal Value](#)" barcode on page 253. For example, read "1" and "5" for the scanner to automatically shut down after being idle for 15 seconds.
- 3) Read the "Validate" barcode on the same page to complete this setting.



1.8 Delay between Re-read

This is also referred to as the "Blocking Time", which is used to prevent the scanner from accidentally reading the same barcode twice when the scan mode is set to any of the following modes. Note that this function works when the [Light Source LEDs Behavior](#) function is set to "LEDs ON".

- ▶ Auto Power Off mode
- ▶ Presentation mode



1.9 Read Redundancy (1D)

Select the level of reading security. For example,

- ▶ If "No Redundancy" is selected, one successful decoding will make the reading valid and induce the "READER Event".
- ▶ If "Two Times" is selected, it will take a total of three consecutive successful decoding of the same barcode to make the reading valid. The higher the reading security is (that is, the more redundancy the user selects), the slower the reading speed gets.

It is obvious that the more redundancy selected, the higher the reading security is, and thus, the slower the reading speed becomes. It will have to compromise between reading security and decoding speed.

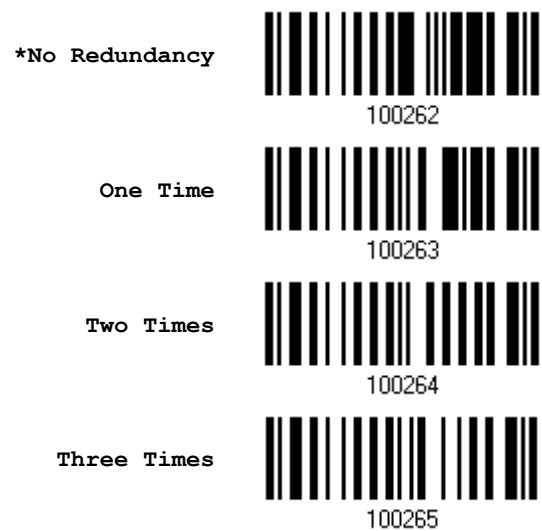

1.10 Addon Security for UPC/EAN Barcodes

The scanner is capable of decoding a mix of UPC/EAN barcodes with or without addons. The read redundancy (2~30 times; default is set to 2) allows changing the number of times to decode a UPC/EAN barcode before transmission. The more redundancy selected, the higher the reading security is, and thus, the slower the reading speed becomes. It will have to compromise between reading security and decoding speed.

Note: UPC/EAN Addon 2 and Addon 5 must be enabled individually for this setting to take effect.

Addon Security Level
(*2~30)



- 1) Read the barcode above to specify the read redundancy for UPC/EAN barcodes. (It is set to 2 by default.)
- 2) Read the "[Decimal Value](#)" barcode on page 253. For example, read "1" and "2" for the scanner to re-read the barcode for 12 times.
- 3) Read the "Validate" barcode on the same page to complete this setting.



1.11 Cable Auto-Detection

Find the interface cable provided inside the package. Connect it to the scanner. The scanner will detect the interface automatically. Refer to [Chapter 2 Selecting Output Interface](#).

Cable Auto-Detect	Defaults
Keyboard Wedge	PCAT (US) for keyboard type
RS-232	115200 bps, 8 bits, No parity, 1 stop bit
USB	USB HID and PCAT (US) for keyboard type

Note: If "USB Virtual COM" is desired, have the scanner read the setup barcodes.

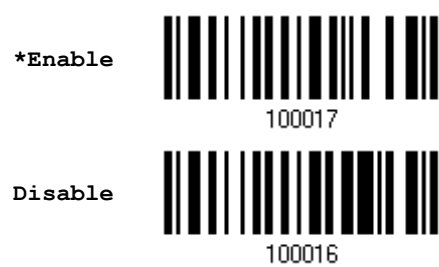

1.12 Mobile Phone/Display Mode

There is a big improvement in reading barcodes displayed on mobile phones and electronic displays when this mode is enabled.



1.13 2D Decode Settings

1.13.1 Aiming Pattern

Enable/Disable the aiming pattern during scanning.



1.13.2 Decoding Illumination

Enable/Disable illumination during scanning.

- ▶ Enabling illumination usually results in superior images. The effectiveness of the illumination decreases as the distance to the target increases.

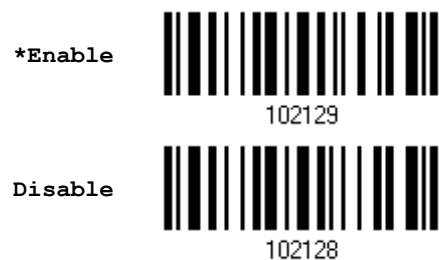

Selecting Output Interface

In order to establish a proper connection between computer and the scanner, we suggest following these instructions –

- 1) Connect the scanner and computer with the provided interface cable. The scanner is capable of detecting the interface.
 - ▶ If using the RS-232 cable, join the power supply cord.
 - ▶ If using the USB cable, the interface is set to USB HID by default (can be configured to USB Virtual COM or USB Virtual COM_CDC).

If “USB Virtual COM” is desired, have the scanner read the setup barcodes.

Cable Auto-Detect	Defaults
Keyboard Wedge	PCAT (US) for keyboard type
RS-232	115200 bps, 8 bits, No parity, 1 stop bit
USB	USB HID and PCAT (US) for keyboard type

- 2) Have the scanner read the “Enter Setup” barcode to enter the configuration mode.
- 3) Have the scanner read the associated barcodes to activate the desired interface.
See the following sections for output interfaces supported.
- 4) Have the scanner read the barcodes for related settings.
- 5) Have the scanner read the “Update” barcode to apply the settings and quit the configuration mode.

In This Chapter

2.1 Keyboard Wedge.....	44
2.2 RS-232	56
2.3 Direct USB HID	61
2.4 Direct USB VCOM	74
2.5 Direct USB VCOM_CDC	76
2.6 Direct USB OPOS	78



2.1 Keyboard Wedge

The Y cable allows connecting the scanner to the keyboard input port of PC and joining the keyboard as well. The scanned data will be transmitted to the host keyboard port as if it is manually entered via the keyboard.

Keyboard Wedge Settings	Defaults
Keyboard Type	PCAT (US)
Alphabets Layout	Normal
Digits Layout	Normal
Capital Lock Type	Normal
Capital Lock State	Off
Alphabets Transmission	Case-sensitive
Digits Transmission	Alphanumeric keypad
Kanji Transmission	Disable
Alternate Composing	No
Laptop Support	Disable
Inter-Character Delay	0 (ms)
Inter-Function Delay	0 (ms)



2.1.1 Activate Keyboard Wedge & Select Keyboard Type

When Keyboard Wedge interface is activated, you have to select a keyboard type to complete this setting.

Activate Keyboard
Wedge & Select
Keyboard Type...



- 1) Read this barcode above to activate Keyboard Wedge and select a keyboard type.
- 2) Read the "[Decimal Value](#)" barcode on page 253. Refer to the table below for the number of desired keyboard type.
- 3) Read the "Validate" barcode on the same page to complete this setting.

Keyboard Type

By default, the keyboard type is set to PCAT (US). The following keyboard types are supported –

No.	Keyboard Type	No.	Keyboard Type
1	PCAT (US)	26	IBM 3477 Type 4 (Japanese)
2	PCAT (French)	27	PS2-30
3	PCAT (German)	28	IBM 34XX/319X, Memorex Telex 122 Keys
4	PCAT (Italian)	29	User-defined table
5	PCAT (Swedish)	30	PCAT (Turkish)
6	PCAT (Norwegian)	31	PCAT (Hungarian)
7	PCAT (UK)	32	PCAT (Swiss German)
8	PCAT (Belgium)	33	PCAT (Danish)
9	PCAT (Spanish)	34	Reserved
10	PCAT (Portuguese)	35	PCAT (Greek)
11	PS55 A01-1	36	Reserved
12	PS55 A01-2 (Japanese)	37	PCAT (Russian)
13	PS55 A01-3	38	Reserved
14	PS55 001-1	39	Reserved
15	PS55 001-81	40	Reserved
16	PS55 001-2	41	Reserved
17	PS55 001-82	42	PCAT (Cyrillic on Russian)
18	PS55 001-3	43	PCAT (Armenian)
19	PS55 001-8A	44	PCAT (Thai)
20	PS55 002-1, 003-1	45	PCAT (Slovenian)
21	PS55 002-81, 003-81	46	PCAT (Mexican Spanish)



22	PS55 002-2, 003-2	47	PCAT (Traditional Chinese)
23	PS55 002-82, 003-82	48	PCAT (Swiss French)
24	PS55 002-3, 003-3	49	PCAT (Czech)
25	PS55 002-8A, 003-8A		

2.1.2 Keyboard Settings

- ▶ Alphabets Layout
- ▶ Digits Layout
- ▶ Capital Lock Type
- ▶ Capital Lock Setting
- ▶ Alphabets Transmission
- ▶ Digits Transmission
- ▶ Kanji Transmission
- ▶ Alternate Composing
- ▶ Laptop Support

Alphabets Layout

By default, the alphabets layout is set to normal mode, also known as the standard English layout. Select French or German keyboard layout if necessary. The scanner will make adjustments when sending the "A", "Q", "W", "Z", "Y", and "M" characters according to this setting.



Note: This setting only works when the keyboard type selected is US keyboard, such as PCAT (US). The Alphabets Layout and Digits Layout setting must match the keyboard.



US Keyboard Style – Normal

QWERTY layout, which is normally used in western countries.

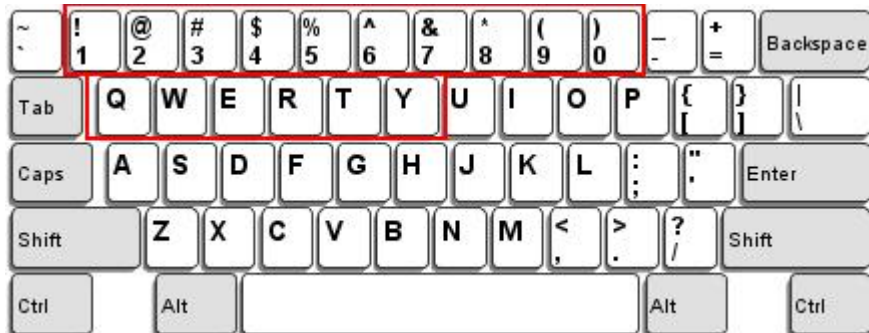

- ▶ Select "Lower Row" for the "Digits Layout" setting because the upper row is for special characters.

French Keyboard Style – AZERTY

French layout; see below for French Keyboard Style.



- ▶ Select "Upper Row" for the "Digits Layout" setting because the lower row is for special characters.

German Keyboard Layout – QWERTZ

German layout; see below for German Keyboard Style.



- ▶ Select "Lower Row" for the "Digits Layout" setting because the upper row is for special characters.



Digits Layout

Select a proper layout that matches Alphabets Layout settings. The scanner will make adjustments according to this setting.

Options	Description
Normal	Depends on the [Shift] key or [Shift Lock] setting
Lower Row	For QWERTY or QWERTZ keyboard
Upper Row	For AZERTY keyboard

***Normal**



100046

Upper Row



100049

Lower Row



100048

Note: This setting is meant to be used with the Alphabets Layout; and perhaps with the Character Substitution setting when support to certain keyboard types (languages) is unavailable but required.



Capital Lock Type & Setting

In order to send the alphabets with correct case, the scanner needs to know the status of Caps Lock on the keyboard. Incorrect settings may result in reversed case of the alphabets being transmitted.

Cap Lock Type	Description
Normal	Normal type
Capital Lock	When enabled, the keys of alphabetic characters will be interpreted as capital letters. However, this does not affect the number or punctuation keys.
Shift Lock	When enabled, the keys of alphabetic characters will be interpreted as capital letters. In addition, this affects the number or punctuation keys.

*Normal 
100042

Shift Lock 
100045

Capital Lock 
100044

Capital Lock State	Description
Capital Lock OFF	Assuming that the status of Caps Lock on the keyboard is OFF, transmitted characters are exactly the same as in the barcode (when "case-sensitive" is selected for Alphabets Transmission).
Capital Lock ON	Assuming that the status of Caps Lock on the keyboard is ON, transmitted characters are exactly the same as in the barcode (when "case-sensitive" is selected for Alphabets Transmission). ▶ Refer to the Capital Lock Type above.
Auto Detection	The scanner will automatically detect the status of Caps Lock on the keyboard before data is transmitted; transmitted characters are exactly the same as in the barcode (when "case-sensitive" is selected for Alphabets Transmission).

Auto Detect 
100054

Capital Lock ON 
100053



*Capital Lock OFF



Alphabets Transmission

By default, the alphabets transmission is case-sensitive, meaning that the alphabets will be transmitted according to their original case, the status of Caps Lock on the keyboard, as well as the Capital Lock setting. Select [Ignore Case] to have alphabets transmitted according to the status of Caps Lock on the keyboard only.

Ignore Case



*Case-sensitive



1. Letter Case for Output Format

Refer to 4.1 Letter Case.



2. Alphabets Transmission for Keyboard Wedge & Bluetooth HID



3a. Check Caps Lock on the keyboard



3b. Check Caps Lock on the keyboard



4. Check Capital Lock setting

*Capital Lock OFF		
Capital Lock ON		
Auto Detection		



Digits Transmission

By default, the alphanumeric keypad is used for transmitting digits. Select "Numeric Keypad" if wishing to use the keys on the numeric keypad.

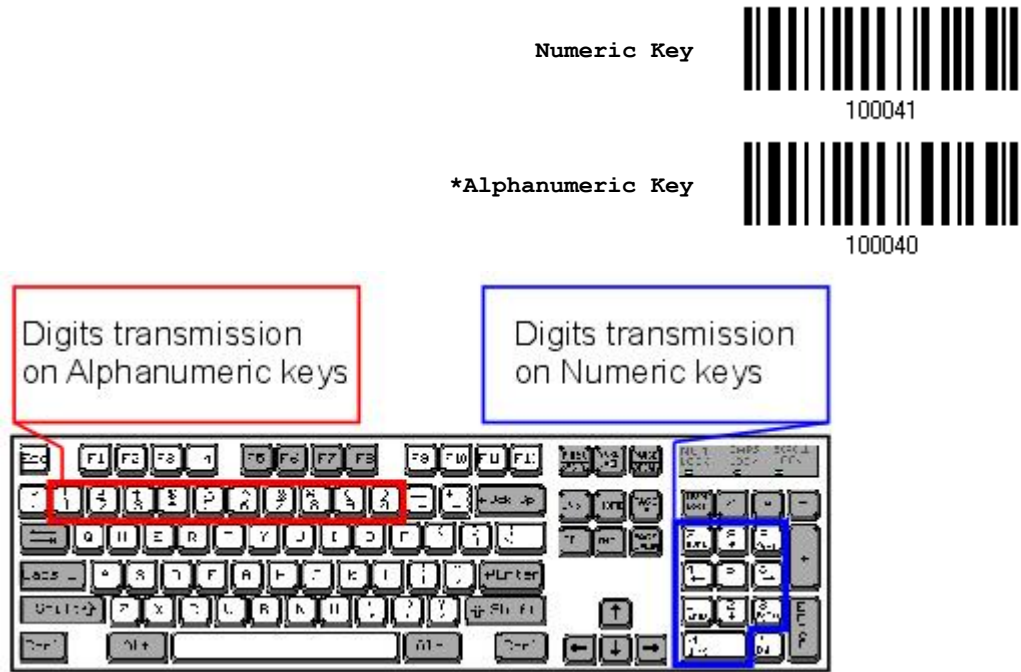

Note: If selecting "Numeric Keypad", the Num Lock status of the physical keyboard should be "ON".

Kanji Transmission

Kanji Transmission is supported by the scanner when either Keyboard Wedge or Direct USB HID is selected for the output interface. By Kanji Transmission, when the host computer is running on Japanese Windows O.S., the scanner is able to transmit Japanese characters including the Chinese characters used in modern Japanese writing system.

Kanji Transmission is disabled by default. Enable/disable scanner's Kanji Transmission by reading the following barcodes:



ALT Composing

By default, Alternate key composing is disabled. Select [Yes] to allow emulating Alternate key code of a specific keyboard character. For example, [Alt] + [065] will be sent to host for the character "A" regardless the keyboard type using.



Laptop Support

By default, laptop support value is disabled. It suggests enabling this feature if connecting the wedge cable to a laptop without an external keyboard being inter-connected.

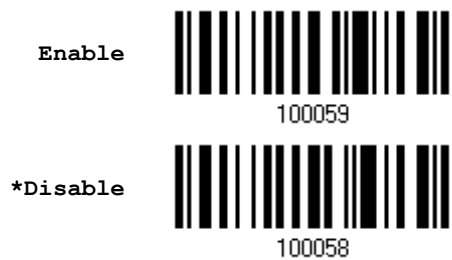

2.1.3 Inter-Character Delay

By default, the inter-character delay is set to zero. Specify a value, ranging from 0 to 254 in units of millisecond, to match the computer response time of the keyboard interface. Such delay time is inserted between every character being transmitted. The longer the delay time is, the slower the transmission speed will be.

Inter-Character
Delay... (*0~254)



- 1) Read the barcode above to specify the inter-character delay.
- 2) Read the "[Decimal Value](#)" barcode on page 253 for the desired inter-character delay (millisecond).
- 3) Read the "Validate" barcode on the same page to complete this setting.

2.1.4 Inter-Function Delay

By default, the inter-function delay is set to zero. Specify a value, ranging from 0 to 254 in units of millisecond, to match the computer response time of the keyboard interface. Such delay time is inserted between every function code (0x01 ~ 0x1F) being transmitted. The longer the delay time is, the slower the transmission speed will be.

Inter-Function
Delay... (*0~254)



- 1) Read the barcode above to specify the inter-function delay.
- 2) Read the "[Decimal Value](#)" barcode on page 253 for the desired inter-function delay (millisecond).
- 3) Read the "Validate" barcode on the same page to complete this setting.



2.1.5 Special Keyboard Feature

By default, this interface doesn't employ special function codes (0x01 ~ 0x1F) defined in the Keyboard Wedge Table for users may want to get rid of these special codes within the barcodes to avoid data error.

Or you can enable the "Bypass with Control Character Output for Windows" function to output control characters ranging from 0x01 to 0x1F in text form. For instance, [BS] (the backspace) is output rather than 0x08 when this function is enabled.

You can decide whether to apply the special keyboard feature. For further details please refer to [Keyboard Wedge Table](#).

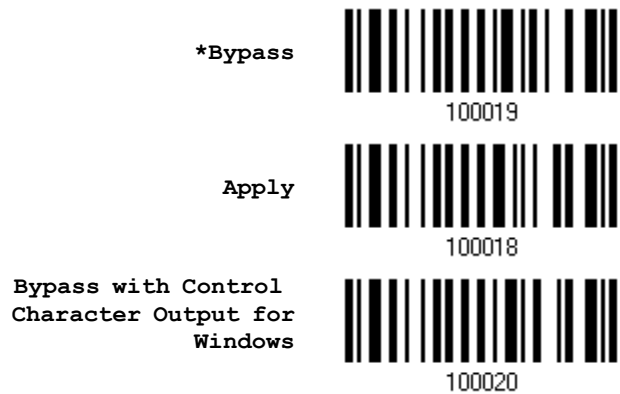

2.1.6 UTF-8 Conversion

This function, disabled by default, is only for certain keyboard types listed in the table below. Enable this function to get the UTF-8-encoded data.

No.	Keyboard Type	No.	Keyboard Type
35	PCAT (Greek)	45	PCAT (Slovenian)
37	PCAT (Russian)	46	PCAT (Mexican Spanish)
42	PCAT (Cyrillic on Russian)	47	PCAT (Traditional Chinese)
43	PCAT (Armenian)	48	PCAT (Swiss French)
44	PCAT (Thai)	49	PCAT (Czech)



Traditional Chinese to Microsoft Word

Generally, there's no problem receiving data using kinds of text editor except Microsoft Word. Please enable this function while using Microsoft Word.



2.2 RS-232

Use the RS-232 cable to connect the scanner to the serial port of PC and join the power adaptor to the RS-232 connector. The associated RS-232 parameters must match those configured on the computer. The scanned data will be transmitted to the serial port.

RS-232 Settings	Defaults
Baud Rate, Data Bit, Parity, Stop Bit	115200 bps, 8 bits, No parity, 1 stop bit
Flow Control	None
Inter-Character Delay	0 (ms)
Inter-Function Delay	0 (ms)
ACK/NAK Timeout	0
ACK/NAK Beep	Disable

2.2.1 Activate RS-232 Interface

Activate RS-232
Interface



2.2.2 Baud Rate

*115200 bps



57600 bps



38400 bps



19200 bps



9600 bps



4800 bps





2.2.3 Data Bits



2.2.4 Parity

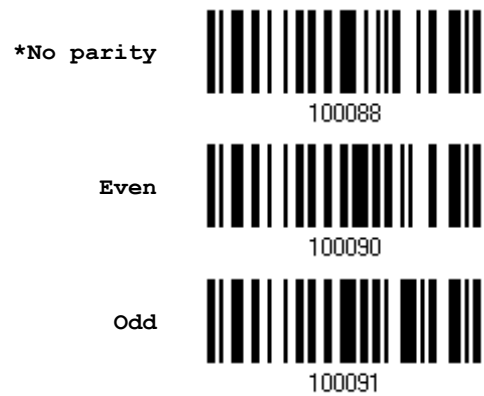

2.2.5 Stop Bit

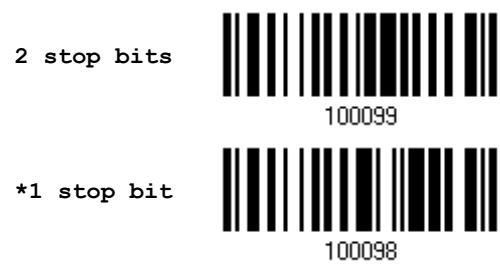

2.2.6 Flow Control

By default, there is no flow control in use. Select the flow control (handshake) method.

Options	Description
No	No flow control
Scanner Ready	The scanner will activate the RTS signal upon powering on. After each good read, the scanner will then wait for the CTS signal to become active. Data will not be sent until the CTS signal becomes active.
Data Ready	The RTS signal will be activated after each good read. The scanner will then wait for the CTS signal to become active. Data will not be sent until the CTS signal becomes active.
Inverted Data Ready	It works the same as the Data Ready flow control except that the RTS signal level is inverted.



2.2.7 Inter-Character Delay

By default, the inter-character delay is zero. Specify a value, ranging from 0 to 254 in units of millisecond, to match the computer response time. Such delay time is inserted between every character being transmitted. The longer the delay time is, the slower the transmission speed will be.

Inter-Character
Delay... (*0~254)



- 1) Read the barcode above to specify the inter-character delay.
- 2) Read the "[Decimal Value](#)" barcode on page 253 for the desired inter-character delay (millisecond).
- 3) Read the "Validate" barcode on the same page to complete this setting.

2.2.8 Inter-Function Delay

By default, the inter-function delay is set to zero. Specify a value, ranging from 0 to 254 in units of millisecond, to match the computer response time of the keyboard interface. Such delay time is inserted between every function code (0x01 ~ 0x1F) being transmitted. The longer the delay time is, the slower the transmission speed will be.

Inter-Function
Delay... (*0~254)



- 1) Read this barcode above to specify the inter-function delay.
- 2) Read the "[Decimal Value](#)" barcode on page 253 for the desired inter-function delay (millisecond).
- 3) Read the "Validate" barcode on the same page to complete this setting.



2.2.9 ACK/NAK Timeout

By default, the scanner sends data to the host without waiting for an ACK/NAK response before sending more data. Specify a value, ranging from 1 to 99 in units of 0.1 second. If no response within the specified period of time, the scanner will attempt to send the same data two more times. If all three attempts fail without any notification, data loss will occur.

ACK/NAK Time-out
after ... (*0~99)



100013

- 1) Read the barcode above to specify the time interval for the scanner to send data and wait for a response from the host.
- 2) Read the "[Decimal Value](#)" barcode on page 253. For example, read "1" and "0" for the scanner to automatically shut down after being idle for 1 second.
- 3) Read the "Validate" barcode on the same page to complete this setting.

ACK/NAK Error Beep

Enable Error Beep



100015

*Disable Error Beep



100014

Note: We suggest enabling the error beep to notice of such data loss and have the scanner re-read data.



2.3 Direct USB HID

For USB HID, connect the scanner to the USB port of PC. Run any text editor on the computer to which the scanned data will be transmitted.

HID Settings	Defaults
Keyboard Type	PCAT (US)
Digits Layout	Normal
Capital Lock Type	Normal
Capital Lock State	Off
Alphabets Transmission	Case-sensitive
Digits Transmission	Alphanumeric keypad
Kanji Transmission	Disable
Inter-Character Delay	0 (ms)
Inter-Function Delay	0 (ms)
Alternate Composing	No



2.3.1 Activate USB HID & Select Keyboard Type

With the USB HID interface activated, you have to select a keyboard type to complete this setting.



- 1) Read the barcode above to activate USB HID and select a keyboard type.
- 2) Read the “[Decimal Value](#)” barcode on page 253. Refer to the table below for the number of desired keyboard type.
- 3) Read the “Validate” barcode on the same page to complete this setting.

USB HID

By default, the keyboard type is set to PCAT (US). The following keyboard types are supported —

No.	Keyboard Type	No.	Keyboard Type
64	PCAT (US)	80	Reserved
65	PCAT (French)	81	PCAT (Greek)
66	PCAT (German)	82	Reserved
67	PCAT (Italy)	83	PCAT (Russian)
68	PCAT (Swedish)	84	Reserved
69	PCAT (Norwegian)	85	Reserved
70	PCAT (UK)	86	Reserved
71	PCAT (Belgium)	87	Reserved
72	PCAT (Spanish)	88	PCAT (Cyrillic on Russian)
73	PCAT (Portuguese)	89	PCAT (Armenian)
74	PS55 A01-2 (Japanese)	90	PCAT (Thai)
75	User-defined table	91	PCAT (Slovenian)
76	PCAT (Turkish)	92	PCAT (Mexican Spanish)
77	PCAT (Hungarian)	93	PCAT (Traditional Chinese)
78	PCAT (Swiss German)	94	PCAT (Swiss French)
79	PCAT (Danish)	95	PCAT (Czech)



The following keyboard types are supported for Apple —

No.	Keyboard Type (Apple)	No.	Keyboard Type (Apple)
64	Apple (US)	78	Apple (Swiss German)
65	Apple (French)	79	Apple (Danish)
66	Apple (German)	80	Apple (Dutch)
67	Apple (Italian)	81	Apple (Greek)
68	Apple (Swedish)	82	Apple (Hebrew)
69	Apple (Norwegian)	83	Apple (Russian)
72	Apple (Spanish)	84	Apple (Flemish)
73	Apple (Portuguese)	85	Apple (Arabic)
75	User-defined table	86	Apple (Austria German)
76	Apple (Turkish)	87	Apple (Brazilian Portuguese)

Note: 81/82/83/85 keyboard types don't support English input.

By default, the scanner uses non-Apple keyboard layout. Read the following barcodes to toggle between Apple and non-Apple keyboard layouts.

Toggle to Apple
Keyboard Layout



100176

*Non-Apple Keyboard
Layout



100175



2.3.2 Keyboard Settings

- ▶ Alphabets Layout
- ▶ Digits Layout
- ▶ Capital Lock Type
- ▶ Capital Lock Setting
- ▶ Alphabets Transmission
- ▶ Digits Transmission
- ▶ Kanji Transmission
- ▶ Alternate Composing

Alphabets Layout

By default, the alphabets layout is set to normal mode, also known as the standard English layout. Select French or German keyboard layout if necessary. The scanner will make adjustments when sending the "A", "Q", "W", "Z", "Y", and "M" characters according to this setting.



Note: This setting only works when the keyboard type selected is US keyboard, such as PCAT (US). The Alphabets Layout and Digits Layout setting must match the keyboard.



US Keyboard Style – Normal

QWERTY layout, which is normally used in western countries.

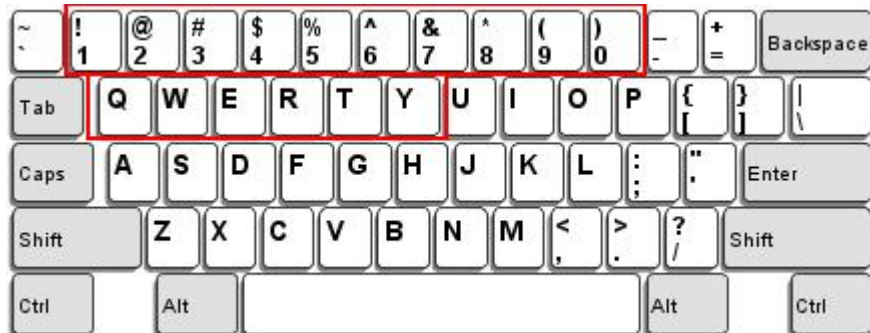

- ▶ Select "Lower Row" for the "Digits Layout" setting because the upper row is for special characters.

French Keyboard Style – AZERTY

French layout; see below for French Keyboard Style.



- ▶ Select "Upper Row" for the "Digits Layout" setting because the lower row is for special characters.

German Keyboard Layout – QWERTZ

German layout; see below for German Keyboard Style.



- ▶ Select "Lower Row" for the "Digits Layout" setting because the upper row is for special characters.



Digits Layout

Select a proper layout that matches the alphabets layout. The scanner will make adjustments according to this setting.

Options	Description
Normal	Depends on the [Shift] key or [Shift Lock] setting
Lower Row	For QWERTY or QWERTZ keyboard
Upper Row	For AZERTY keyboard

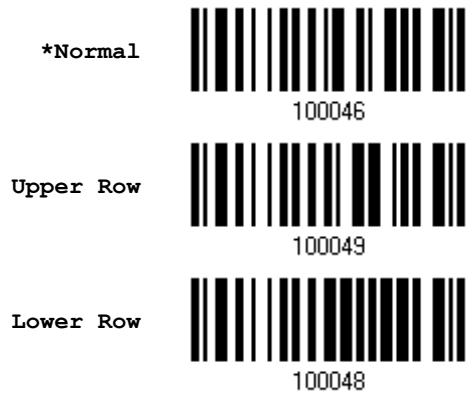

Note: This setting is to be used with the Character Substitution setting when support to certain keyboard types (languages) is unavailable but required.



Capital Lock Type & Setting

In order to send the alphabets with correct case, the scanner needs to know the status of Caps Lock on the keyboard. Incorrect settings may result in reversed case of the alphabets being transmitted.

Cap Lock Type	Description
Normal	Normal type
Capital Lock	When enabled, the keys of alphabetic characters will be interpreted as capital letters. However, this does not affect the number or punctuation keys.
Shift Lock	When enabled, the keys of alphabetic characters will be interpreted as capital letters. In addition, this affects the number or punctuation keys.



Capital Lock State	Description
Capital Lock OFF	Assuming that the status of Caps Lock on the keyboard is OFF, transmitted characters are exactly the same as in the barcode (when "case-sensitive" is selected for Alphabets Transmission).
Capital Lock ON	Assuming that the status of Caps Lock on the keyboard is ON, transmitted characters are exactly the same as in the barcode (when "case-sensitive" is selected for Alphabets Transmission). ▶ Refer to the Capital Lock Type above.
Auto Detection	The scanner will automatically detect the status of Caps Lock on the keyboard before data is transmitted; transmitted characters are exactly the same as in the barcode (when "case-sensitive" is selected for Alphabets Transmission).

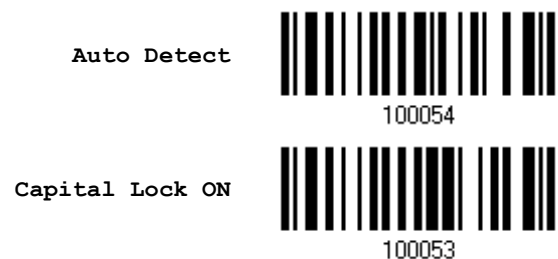

*Capital Lock OFF



Alphabets Transmission

By default, the alphabets transmission is case-sensitive, meaning that the alphabets will be transmitted according to their original case, the status of Caps Lock on the keyboard, as well as the Capital Lock setting. Select [Ignore Case] to have alphabets transmitted according to the status of Caps Lock on the keyboard only.

Ignore Case



*Case-sensitive



1. Letter Case for Output Format

Refer to 4.1 Letter Case.



2. Alphabets Transmission for Keyboard Wedge & Bluetooth HID



3a. Check Caps Lock on the keyboard

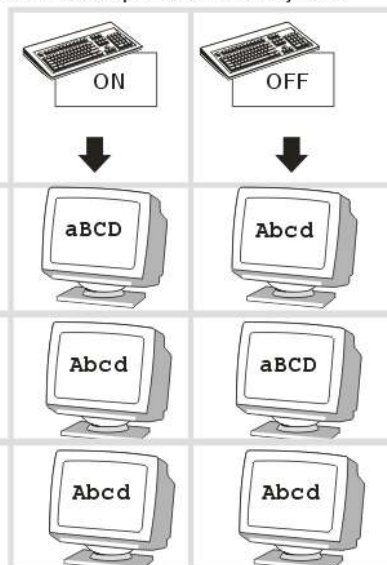

3b. Check Caps Lock on the keyboard

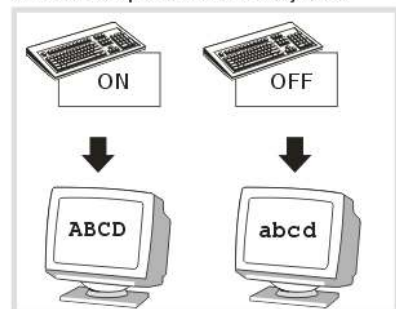

4. Check Capital Lock setting

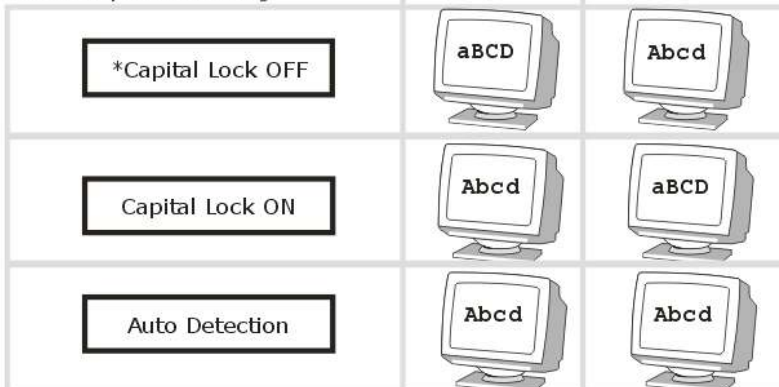

Digits Transmission

By default, the alphanumeric keypad is used for transmitting digits. Select "Numeric Keypad" to use the keys on the numeric keypad.

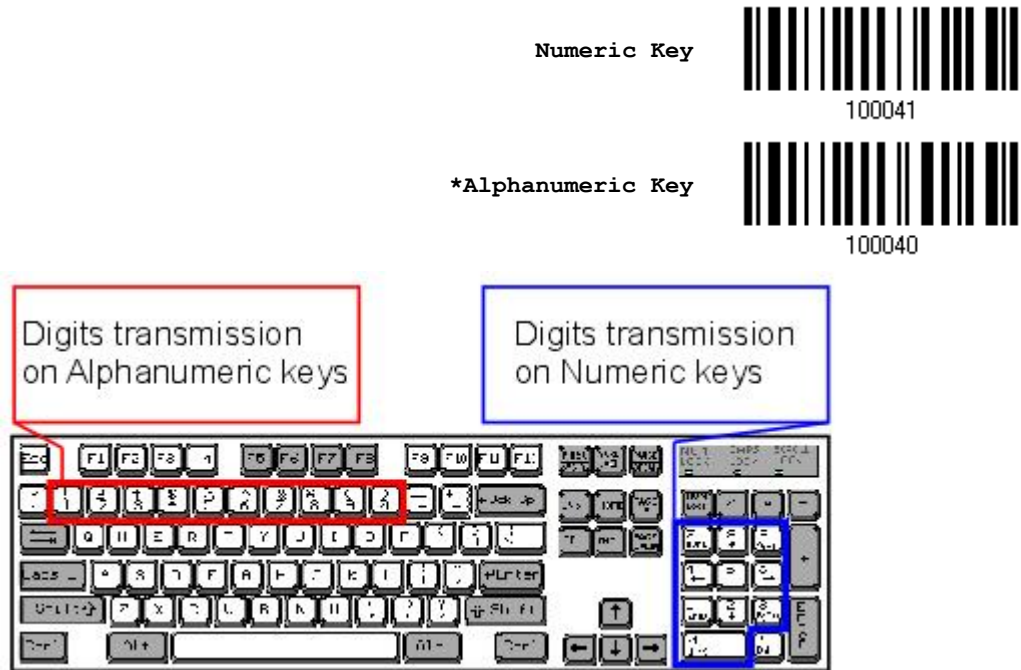

Note: If selecting "Numeric Keypad", the Num Lock status of the physical keyboard should be "ON".

Kanji Transmission

Kanji Transmission is supported by the scanner when either Keyboard Wedge or Direct USB HID is selected for the output interface. By Kanji Transmission, when the host computer is running on Japanese Windows O.S., the scanner is able to transmit Japanese characters including the Chinese characters used in modern Japanese writing system.

Kanji Transmission is disabled by default. Enable/disable scanner's Kanji Transmission by reading the following barcodes:



ALT Composing

By default, Alternate key composing is disabled. Select [Yes] to allow emulating Alternate key code of a specific keyboard character. For example, [Alt] + [065] will be sent to host for the character "A" regardless the keyboard type using.





2.3.3 Inter-Character Delay

By default, the inter-character delay is set to zero. Specify a value, ranging from 0 to 254 in units of millisecond, to match the computer response time of the keyboard interface. Such delay time is inserted between every character being transmitted. The longer the delay time is, the slower the transmission speed will be.

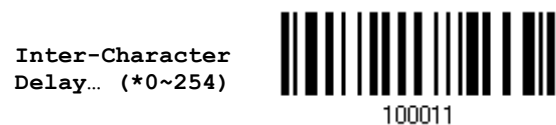

- 1) Read the barcode above to specify the inter-character delay.
- 2) Read the "[Decimal Value](#)" barcode on page 253 for the desired inter-character delay (millisecond).
- 3) Read the "Validate" barcode on the same page to complete this setting.

2.3.4 Inter-Function Delay

By default, the inter-function delay is set to zero. Specify a value, ranging from 0 to 254 in units of millisecond, to match the computer response time of the keyboard interface. Such delay time is inserted between every function code (0x01 ~ 0x1F) being transmitted. The longer the delay time is, the slower the transmission speed will be.

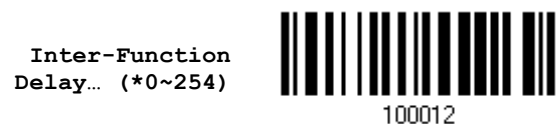

- 1) Read the barcode above to specify the inter-function delay.
- 2) Read the "[Decimal Value](#)" barcode on page 253 for the desired inter-function delay (millisecond).
- 3) Read the "Validate" barcode on the same page to complete this setting.



2.3.5 HID Character Transmit Mode

By default, HID interface sends data to the host character by character. You may have the scanner read the "Batch Processing" barcode to process data in batch.

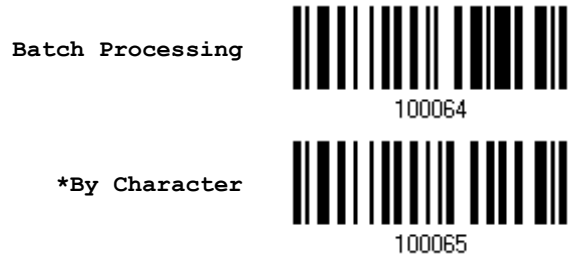

Note: "By Character" transmit mode is required when working with iPhone or iPad. It's recommended that the Auto-Correction function on your iOS keyboard should be turned off.

2.3.6 Special Keyboard Feature

Please refer to [2.1.5 Special Keyboard Feature](#).



2.3.7 UTF-8 Conversion

This function, disabled by default, is only for certain keyboard types listed in the table below. Enable this function to get the UTF-8-encoded data.

No.	Keyboard Type	No.	Keyboard Type
81	PCAT (Greek)	91	PCAT (Slovenian)
83	PCAT (Russian)	92	PCAT (Mexican Spanish)
88	PCAT (Cyrillic on Russian)	93	PCAT (Traditional Chinese)
89	PCAT (Armenian)	94	PCAT (Swiss French)
90	PCAT (Thai)	95	PCAT (Czech)

Enable



100023

*Disable



100022

Traditional Chinese to Microsoft Word

Generally, there's no problem receiving data using kinds of text editor except Microsoft Word. Please enable this function while using Microsoft Word.

Enable



100025

*Disable



100024



2.3.8 USB Polling Interval

Scan the barcodes below to specify the USB polling interval ranging from 1 to 15ms.

Set USB polling interval
1~15 ms (*4)



- 1) Read the barcode above to specify the USB polling interval time.
- 2) Read the "[Decimal Value](#)" barcode on page 253.
- 3) Read the "Validate" barcode on the same page to complete this setting.



Update

2.4 Direct USB VCOM

For USB Virtual COM, connect the scanner to the USB port of PC. Run a utility like HyperTerminal.exe on the computer, and the scanned data will be transmitted to the computer.

Please refer to [Dual USB Connection](#) for correct cable connection and command/data transmission.

Note: If using USB Virtual COM for the first time, you must install the accompanying driver beforehand. Driver version 5.4 or later is required. Please remove older versions! Instead, users can also decide to use the USB communication device class (CDC) driver by selecting Direct USB VCOM_CDC. Refer to [2.5 Direct USB VCOM CDC](#).

2.4.1 Activate USB Virtual COM

Activate Direct USB
Virtual COM



2.4.2 Inter-Function Delay

By default, the inter-function delay is set to zero. Specify a value, ranging from 0 to 254 in units of millisecond, to match the computer response time of the keyboard interface. Such delay time is inserted between every function code (0x01 ~ 0x1F) being transmitted. The longer the delay time is, the slower the transmission speed will be.

Inter-Function
Delay... (*0~254)



- 1) Read the barcode above to specify the inter-function delay.
- 2) Read the "[Decimal Value](#)" barcode on page 253 for the desired inter-function delay (millisecond).
- 3) Read the "Validate" barcode on the same page to complete this setting.



2.4.3 ACK/NAK Timeout

By default, the scanner sends data to the host without waiting for an ACK/NAK response before sending more data. Specify a value, ranging from 1 to 99 in units of 0.1 second. If no response within the specified period of time, the scanner will attempt to send the same data two more times. If all three attempts fail without any notification, data loss will occur.

ACK/NAK Time-out
after ... (*0~99)



100013

- 1) Read the barcode above to specify the time interval for the scanner to send data and wait for a response from the host.
- 2) Read the "[Decimal Value](#)" barcode on page 253. For example, read "1" and "0" for the scanner to automatically shut down after being idle for 1 second.
- 3) Read the "Validate" barcode on the same page to complete this setting.

ACK/NAK Error Beep

Enable Error Beep



100015

*Disable Error Beep



100014

Note: We suggest enabling the error beep to notice of such data loss and have the scanner re-read data.



2.5 Direct USB VCOM_CDC

For USB Virtual COM, connect the scanner to the USB port of PC. Run a utility like HyperTerminal.exe on the computer, and the scanned data will be transmitted to the computer.

Please refer to [Dual USB Connection](#) for correct cable connection and command/data transmission.

Note: If using USB Virtual COM for the first time, you must install the accompanying VCOM_CDC driver beforehand.

2.5.1 Activate USB VCOM_CDC

Activate
Direct USB VCOM_CDC



2.5.2 Inter-Function Delay

By default, the inter-function delay is set to zero. Specify a value, ranging from 0 to 254 in units of millisecond, to match the computer response time of the keyboard interface. Such delay time is inserted between every function code (0x01 ~ 0x1F) being transmitted. The longer the delay time is, the slower the transmission speed will be.

Inter-Function
Delay... (*0~254)



- 1) Read the barcode above to specify the inter-function delay.
- 2) Read the "[Decimal Value](#)" barcode on page 253 for the desired inter-function delay (millisecond).
- 3) Read the "Validate" barcode on the same page to complete this setting.



2.5.3 ACK/NAK Timeout

By default, the scanner sends data to the host without waiting for an ACK/NAK response before sending more data. Specify a value, ranging from 1 to 99 in units of 0.1 second. If no response within the specified period of time, the scanner will attempt to send the same data two more times. If all three attempts fail without any notification, data loss will occur.

ACK/NAK Time-out
after ... (*0~99)



100013

- 1) Read the barcode above to specify the time interval for the scanner to send data and wait for a response from the host.
- 2) Read the "[Decimal Value](#)" barcode on page 253. For example, read "1" and "0" for the scanner to automatically shut down after being idle for 1 second.
- 3) Read the "Validate" barcode on the same page to complete this setting.

ACK/NAK Error Beep

Enable Error Beep



100015

*Disable Error Beep



100014

Note: We suggest enabling the error beep to notice of such data loss and have the scanner re-read data.



2.6 Direct USB OPOS

Before using the USB OPOS interface, users have to install CipherLab's scanner OPOS kit on the Windows 32/64 bits and Windows Embedded operating systems. Besides, make sure your scanner which supports OPOS has been upgraded.

Change to OPOS



The OPOS Kit (Driver & OPOS User Guide included) can be downloaded from:

<http://scanmaster.cipherlab.com/download/opos/CipherLabOPOSKit-latest.exe>

Please refer to the CipherLab OPOS User Guide for further details.



Changing Symbology Settings

In this chapter, a brief on the symbology settings is provided for reference.

Users can simply scan the setting barcodes below to disable/enable all symbologies.



Settings for each particular symbology will be depicted as follows.

In This Chapter

3.1 Codabar.....	80
3.2 Code 25 – Industrial 25	83
3.3 Code 25 – Interleaved 25.....	86
3.4 Code 25 – Matrix 25	89
3.5 Code 39.....	92
3.6 Code 93	96
3.7 Code 128	97
3.8 EAN-8.....	98
3.9 EAN-13.....	100
3.10 GS1-128 (EAN-128)	105
3.11 ISBT 128.....	107
3.12 MSI	108
3.13 French Pharmacode	110
3.14 Italian Pharmacode	110
3.15 Plessey	111
3.16 GS1 DataBar (RSS Family)	112
3.17 Telepen.....	118
3.18 UPC-A	119
3.19 UPC-E	121
3.20 Code 11	123
3.21 Composite Code.....	126
3.22 2D Symbologies	128



3.1 Codabar

***Enable**



100313

Disable



100312

3.1.1 Security Level

Security Level renders more decoding accuracy giving consideration to barcodes' print quality. The scanner allows you to change the CODABAR security level between high or normal level.

***Normal**



100491

High



100490

3.1.2 Start/Stop Transmission

Decide whether to include the start/stop characters in the data being transmitted.

**Transmit Start/Stop
Characters**



100441

***Do Not Transmit**



100440



3.1.3 Start/Stop Character Selection

Select one of the four different start/stop character pairs –



3.1.4 CLSI Conversion

When enabled, the CLSI editing strips the start/stop characters and inserts a space after the first, fifth, and tenth characters of a 14-character Codabar barcode.

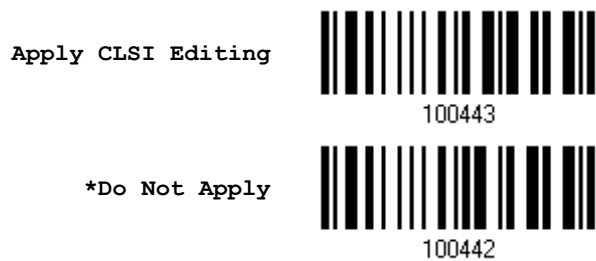

Note: The 14-character barcode length does not include start/stop characters.



3.1.5 Code Length Qualification

To prevent the "short scan" error, define the "Length Qualification" settings to ensure that the correct barcode is read by qualifying the allowable code length.

- ▶ If "Max/Min Length" is selected, the maximum length and the minimum length must be specified. It only accepts those barcodes with lengths that fall between max/min lengths specified.
- ▶ If "Fixed Length" is selected, up to 2 fixed lengths can be specified.

Note: The specified length(s) must include the check digit(s) the barcode contains.

- 1) Read the barcode to enable either Max. /Min. Length qualification or Fixed Length(s) qualification.

***Enable Max./Min.
Length (1~127)...**



**Enable Fixed
Length(s)...**



- 2) Read the barcode for Max. Length or Fixed Length 1, and follow steps 3~4.
Repeat steps 2~4 for Min. Length or Fixed Length 2.

**Max. Length (*127) or
Fixed Length 1**



**Min. Length (*4) or
Fixed Length 2**



- 3) Read the "[Decimal Value](#)" barcode on page 253 for the desired length.
- 4) Read the "Validate" barcode on the same page to complete this setting.



3.2 Code 25 – Industrial 25

*Enable



100307

Disable



100306

3.2.1 Select Start/Stop Pattern

This decides the readability of all 2 of 5 symbology variants. For example, flight tickets actually use an Industrial 2 of 5 barcode but with Interleaved 2 of 5 start/stop pattern. In order to read this barcode, the start/stop pattern selection parameter of Industrial 2 of 5 should set to "Interleaved 25".

*Industrial 25
Start/Stop Pattern



100412

Interleaved 25
Start/Stop Pattern



100413

Matrix 25
Start/Stop Pattern



100414

3.2.2 Verify Check Digit

Decide whether to verify the check digit. If incorrect, the barcode will not be accepted.

Verify Industrial 25
Check Digit



100425

*Do Not Verify



100424



3.2.3 Transmit Check Digit

Decide whether to include the check digit in the data being transmitted.



3.2.4 Code Length Qualification

To prevent the "short scan" error, define the "Length Qualification" settings to ensure that the correct barcode is read by qualifying the allowable code length.

- ▶ If "Max/Min Length" is selected, the maximum length and the minimum length must be specified. It only accepts those barcodes with lengths that fall between max/min lengths specified.
- ▶ If "Fixed Length" is selected, up to 2 fixed lengths can be specified.

Note: The specified length(s) must include the check digit(s) the barcode contains.

- 1) Read the barcode to enable either Max. /Min. Length qualification or Fixed Length(s) qualification.

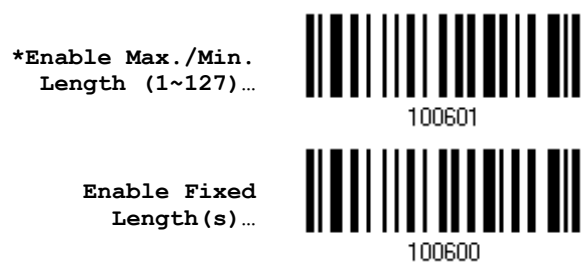

- 2) Read the barcode for Max. Length or Fixed Length 1, and follow steps 3~4.
Repeat steps 2~4 for Min. Length or Fixed Length 2.



Max. Length (*127) or
Fixed Length 1



100602

Min. Length (*4) or
Fixed Length 2



100603

- 3) Read the "[Decimal Value](#)" barcode on page 253 for the desired length.
- 4) Read the "Validate" barcode on the same page to complete this setting.



3.3 Code 25 – Interleaved 25

***Enable**



100309

Disable



100308

3.3.1 Select Start/Stop Pattern

This decides the readability of all 2 of 5 symbology variants. For example, flight tickets actually use an Industrial 2 of 5 barcode but with Interleaved 2 of 5 start/stop pattern. In order to read this barcode, the start/stop pattern selection parameter of Industrial 2 of 5 should set to "Interleaved 25".

**Industrial 25
Start/Stop Pattern**



100416

***Interleaved 25
Start/Stop Pattern**



100417

**Matrix 25
Start/Stop Pattern**



100418

3.3.2 Verify Check Digit

Decide whether to verify the check digit. If incorrect, the barcode will not be accepted.

**Verify
Interleaved 25
Check Digit**



100429

***Do Not Verify**



100428



3.3.3 Transmit Check Digit

Decide whether to include the check digit in the data being transmitted.



3.3.4 Code Length Qualification

To prevent the "short scan" error, define the "Length Qualification" settings to ensure that the correct barcode is read by qualifying the allowable code length.

- ▶ If "Max/Min Length" is selected, the maximum length and the minimum length must be specified. It only accepts those barcodes with lengths that fall between max/min lengths specified.
- ▶ If "Fixed Length" is selected, up to 2 fixed lengths can be specified.

Note: The specified length(s) must include the check digit(s) the barcode contains.

- 1) Read the barcode to enable either Max. /Min. Length qualification or Fixed Length(s) qualification.

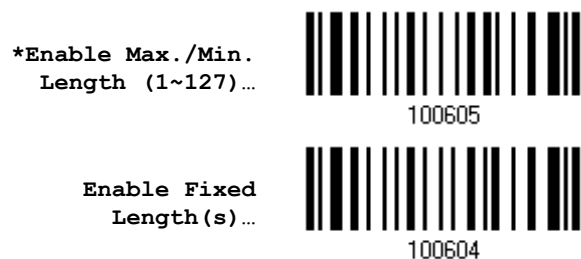

- 2) Read the barcode for Max. Length or Fixed Length 1, and follow steps 3~4.
Repeat steps 2~4 for Min. Length or Fixed Length 2.



Max. Length (*126) or
Fixed Length 1



100606

Min. Length (*4) or
Fixed Length 2



100607

- 3) Read the "[Decimal Value](#)" barcode on page 253 for the desired length.
- 4) Read the "Validate" barcode on the same page to complete this setting.



3.4 Code 25 – Matrix 25

Enable



*Disable



3.4.1 Select Start/Stop Pattern

This decides the readability of all 2 of 5 symbology variants. For example, flight tickets actually use an Industrial 2 of 5 barcode but with Interleaved 2 of 5 start/stop pattern. In order to read this barcode, the start/stop pattern selection parameter of Industrial 2 of 5 should set to "Interleaved 25".

Industrial 25
Start/Stop Pattern



Interleaved 25
Start/Stop Pattern



*Matrix 25
Start/Stop Pattern



3.4.2 Verify Check Digit

Decide whether to verify the check digit. If incorrect, the barcode will not be accepted.

Verify Matrix 25
Check Digit



*Do Not Verify



3.4.3 Transmit Check Digit

Decide whether to include the check digit in the data being transmitted.

*Transmit Matrix 25
Check Digit



100435

Do Not Transmit



100434



3.4.4 Code Length Qualification

To prevent the "short scan" error, define the "Length Qualification" settings to ensure that the correct barcode is read by qualifying the allowable code length.

- ▶ If "Max/Min Length" is selected, the maximum length and the minimum length must be specified. It only accepts those barcodes with lengths that fall between max/min lengths specified.
- ▶ If "Fixed Length" is selected, up to 2 fixed lengths can be specified.

Note: The specified length(s) must include the check digit(s) the barcode contains.

- 1) Read the barcode to enable either Max. /Min. Length qualification or Fixed Length(s) qualification.

*Enable Max./Min.
Length (1~127)...



Enable Fixed
Length (s)...



- 2) Read the barcode for Max. Length or Fixed Length 1, and follow steps 3~4.
Repeat steps 2~4 for Min. Length or Fixed Length 2.

Max. Length (*127) or
Fixed Length 1



Min. Length (*4) or
Fixed Length 2



- 3) Read the "[Decimal Value](#)" barcode on page 253 for the desired length.
- 4) Read the "Validate" barcode on the same page to complete this setting.



3.5 Code 39

***Enable**



100301

Disable



100300

3.5.1 Transmit Start/Stop Characters

Decide whether to verify the check digit. If incorrect, the barcode will not be accepted.

**Transmit Code 39
Start/Stop
Characters**



100403

***Do Not Transmit**



100402

3.5.2 Verify Check Digit

Decide whether to verify the check digit. If incorrect, the barcode will not be accepted.

**Verify Code 39
Check Digit**



100405

***Do Not Verify**



100404



3.5.3 Transmit Check Digit

Decide whether to include the check digit in the data being transmitted.



3.5.4 Standard/Full ASCII Code 39

Decide whether to support Code 39 Full ASCII that includes all the alphanumeric and special characters.

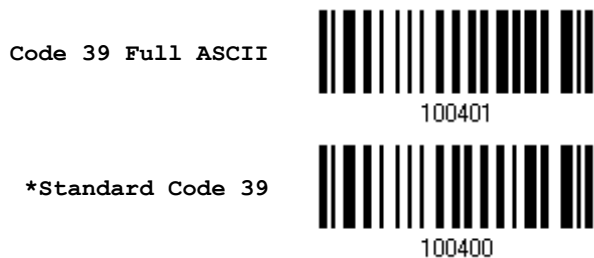

3.5.5 Security Level

Security Level renders more decoding accuracy giving consideration to barcodes' print quality. Decide the security level for reading Code 39 barcodes.



Security Level for Start/Stop Characters

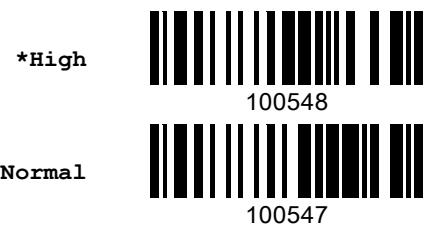

3.5.6 Asterisks (*) as data Characters

Decide whether to take asterisk (*) as part of the data.

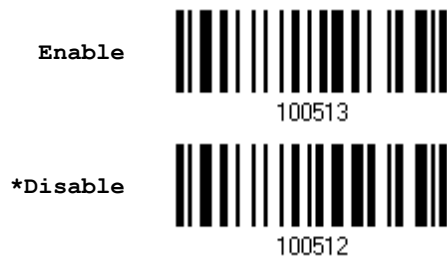

3.5.7 Code Length Qualification

To prevent the "short scan" error, define the "Length Qualification" settings to ensure that the correct barcode is read by qualifying the allowable code length.

- ▶ If "Max/Min Length" is selected, the maximum length and the minimum length must be specified. It only accepts those barcodes with lengths that fall between max/min lengths specified.
- ▶ If "Fixed Length" is selected, up to 2 fixed lengths can be specified.

Note: The specified length(s) must include the check digit(s) the barcode contains.

- 1) Read the barcode to enable either Max. /Min. Length qualification or Fixed Length(s) qualification.



***Enable Max./Min.
Length (1~127)...**



102218

**Enable Fixed
Length(s)...**



102217

- 2) Read the barcode for Max. Length or Fixed Length 1, and follow steps 3~4.
Repeat steps 2~4 for Min. Length or Fixed Length 2.

**Max. Length (*127) or
Fixed Length 1**



102219

**Min. Length (*4) or
Fixed Length 2**



102220

- 3) Read the "[Decimal Value](#)" barcode on page 253 for the desired length.
- 4) Read the "Validate" barcode on the same page to complete this setting.

3.5.8 Quiet Zone Checking

Decide whether to check quiet zones of the target barcode. This function is enabled by default.

Disable

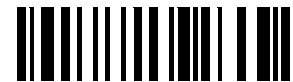

100550

***Enable**



100549



3.6 Code 93

*Enable



Disable



3.6.1 Code Length Qualification

To prevent the "short scan" error, define the "Length Qualification" settings to ensure that the correct barcode is read by qualifying the allowable code length.

- ▶ If "Max/Min Length" is selected, the maximum length and the minimum length must be specified. It only accepts those barcodes with lengths that fall between max/min lengths specified.
- ▶ If "Fixed Length" is selected, up to 2 fixed lengths can be specified.

Note: The specified length(s) must include the check digit(s) the barcode contains.

- 1) Read the barcode to enable either Max. /Min. Length qualification or Fixed Length(s) qualification.

*Enable Max./Min.
Length (1~127)...



Enable Fixed
Length(s)...



- 2) Read the barcode for Max. Length or Fixed Length 1, and follow steps 3~4. Repeat steps 2~4 for Min. Length or Fixed Length 2.

Max. Length (*127) or
Fixed Length 1



Min. Length (*4) or
Fixed Length 2



- 3) Read the "[Decimal Value](#)" barcode on page 253 for the desired length.
- 4) Read the "Validate" barcode on the same page to complete this setting.



3.7 Code 128

***Enable**



100317

Disable



100316

3.7.1 Security Level

Security Level renders more decoding accuracy giving consideration to barcodes' print quality. Decide the security level for reading Code 128 barcodes.

***Normal**



100493

High



100492



Update

3.8 EAN-8

EAN-8

***Enable EAN-8
(No Addon)**



Disable



EAN-8 Addon 2

Enable EAN-8 Addon 2



***Disable**



EAN-8 Addon 5

Enable EAN-8 Addon 5



***Disable**



3.8.1 Convert to EAN-13

Decide whether to expand the read EAN-8 barcode, as well as its addons, into EAN-13.

- ▶ After conversion, the data follows EAN-13 format and is affected by EAN-13 programming selections (e.g. Check Digit).

**Convert EAN-8 to
EAN-13**



***Do Not Convert**



3.8.2 Transmit Check Digit

Decide whether to include the check digit in the data being transmitted.

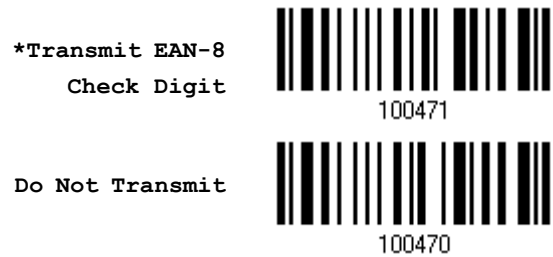

3.8.3 Conversion Format

When converting EAN-8 to EAN-13, you can scan the barcode below to decide conversion in default or GTIN-13 format.

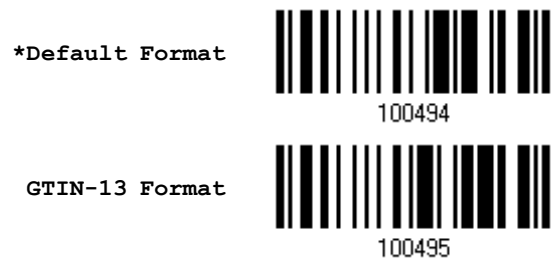

3.9 EAN-13

EAN-13

***Enable EAN-13
(No Addon)**



100333

Disable



100332

EAN-13 Addon 2

Enable EAN-13 Addon 2



100335

***Disable**



100334

EAN-13 Addon 5

Enable EAN-13 Addon 5



100337

***Disable**



100336



3.9.1 EAN-13 Addon Modes

Decide whether to enable EAN-13 414/419/434/439 Addon Mode. When enabled, barcodes starting with 414/419/434/439 won't be decoded if the scanned barcodes do not have the Addon 2 or Addon 5 suffix.

EAN-13 414/419/434/439 Addon Mode

Enable



101337

*Disable



101336

Decide whether to enable EAN-13 378/379 Addon Mode. When enabled, barcodes starting with 378/379 won't be decoded if the scanned barcodes do not have the Addon 2 or Addon 5 suffix.

EAN-13 378/379 Addon Mode

Enable



101339

*Disable



101338

Decide whether to enable EAN-13 977 Addon Mode. When enabled, barcodes starting with 977 won't be decoded if the scanned barcodes do not have the Addon 2 or Addon 5 suffix.

EAN-13 977 Addon Mode

Enable



101341

*Disable



101340



Decide whether to enable EAN-13 978 Addon Mode. When enabled, barcodes starting with 978 won't be decoded if the scanned barcodes do not have the Addon 2 or Addon 5 suffix.

EAN-13 978 Addon Mode



Decide whether to enable EAN-13 979 Addon Mode. When enabled, barcodes starting with 979 won't be decoded if the scanned barcodes do not have the Addon 2 or Addon 5 suffix.

EAN-13 979 Addon Mode



Decide whether to enable EAN-13 491 Addon Mode. When enabled, barcodes starting with 491 won't be decoded if the scanned barcodes do not have the Addon 2 or Addon 5 suffix.

EAN-13 491 Addon Mode



Decide whether to enable EAN-13 529 Addon Mode. When enabled, barcodes starting with 529 won't be decoded if the scanned barcodes do not have the Addon 2 or Addon 5 suffix.

EAN-13 529 Addon Mode



Decide whether to have the scanner buzzer sound two beeps (with tones descending from high to low) when decoding the scanned barcode that doesn't have the Addon 2 or Addon 5 suffix.

EAN-13 Addon Mode Buzzer

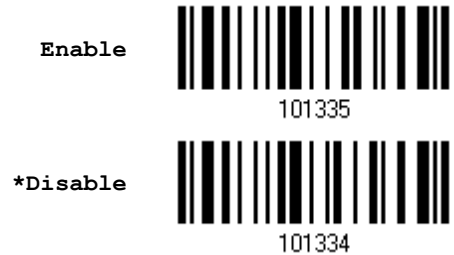

3.9.2 Convert to ISBN

Decide whether to convert the EAN-13 barcode, starting with 978 and 979, to ISBN.

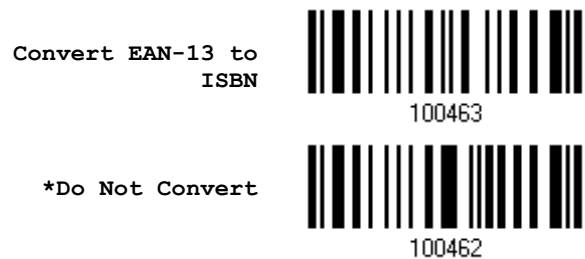

3.9.3 Convert to ISSN

Decide whether to convert the EAN-13 barcode, starting with 977 to ISSN.

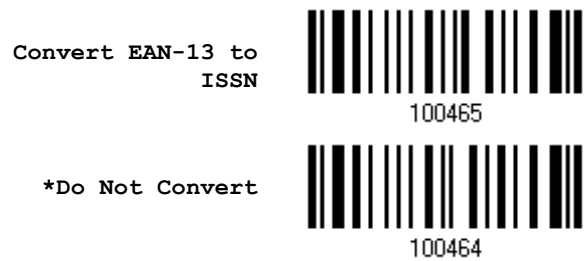

3.9.4 Transmit Check Digit

Decide whether to include the check digit in the data being transmitted.

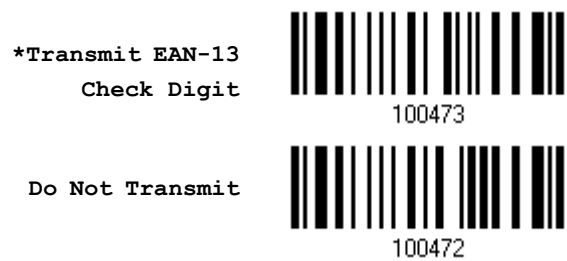

3.9.5 Security Level

Security Level renders more decoding accuracy giving consideration to barcodes' print quality. Decide the security level for reading EAN-13 barcodes.

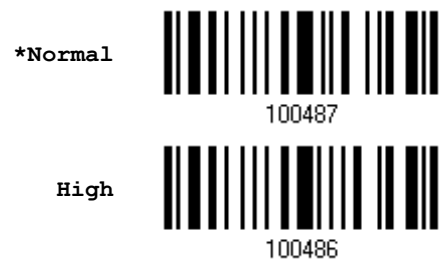

3.10 GS1-128 (EAN-128)



Note: When this setting is disabled, GS1-128 barcodes used to be taken as Code 128.

3.10.1 Transmit Code ID

Decide whether to include the Code ID (“]C1”) in the data being transmitted.

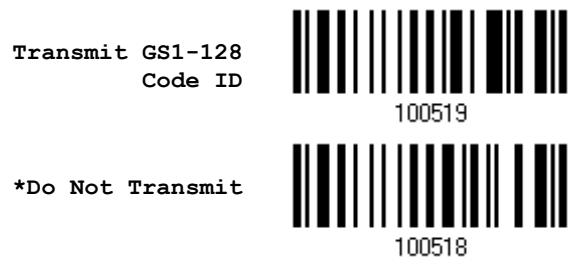

3.10.2 Field Separator (GS Character)

Decide whether to apply a field separator (to convert the FNC1 control character to human readable character).



- 1) Read the barcode above to enable field separator.
- 2) Read the [“Hexadecimal Value”](#) barcode on page 254 for the desired character string.
- 3) Read the “Validate” barcode to complete this setting.

Note: GS1-128 barcodes start with the FNC1 control character to distinguish themselves from other uses of Code 128. FNC1 is also used to separate data fields in the GS1-128 barcodes.



3.10.3 GS1 Formatting

Decide whether to enable GS1 formatting for GS1-128.



3.10.4 Application ID Mark

Decide whether to add an application ID mark (1 character) to the left (AIMark1) or right (AIMark2) of an application ID (AI) for the purpose of labeling it when formatting the GS1 data.



- 1) Read the barcode above to add a mark to the left (AIMark1)/right (AIMark2) of an application ID.
- 2) Read the "[Hexadecimal System](#)" barcode on page 254 for the desired character. Read '00' if you want to remove the AI mark.
- 3) Read the "Validate" barcode to complete this setting.



3.11 ISBT 128

***Enable**



Disable



3.11.1 ISBT Concatenation

Decide whether to decode and concatenate pairs of ISBT barcodes.

▶ **Auto-discriminate ISBT Concatenation**

It decodes and concatenates pairs of ISBT barcodes immediately. If only a single ISBT barcode is present, the scanner must decode 10 times before transmitting its data to confirm that there is no additional ISBT barcode.

▶ **Enable ISBT Concatenation**

There must be two ISBT barcodes in order for the scanner to decode and perform concatenation. It does not decode single ISBT barcodes.

▶ **Disable ISBT Concatenation**

It will not concatenate pairs of ISBT barcodes it encounters.

Auto-discriminate



Enable



***Disable**



3.12 MSI

Enable



*Disable



3.12.1 Verify Check Digit

Select one of the three calculations to verify check digit(s) when decoding barcodes. If incorrect, the barcode will not be accepted.

*Single Modulo 10



Double Modulo 10



Modulo 10 & 11



3.12.2 Transmit Check Digit

Decide whether to include the check digit(s) in the data being transmitted.

*Last Digit Not Transmitted



Both Digits Transmitted



Both Digits Not Transmitted



3.12.3 Code Length Qualification

To prevent the "short scan" error, define the "Length Qualification" settings to ensure that the correct barcode is read by qualifying the allowable code length.

- ▶ If "Max/Min Length" is selected, the maximum length and the minimum length must be specified. It only accepts those barcodes with lengths that fall between max/min lengths specified.
- ▶ If "Fixed Length" is selected, up to 2 fixed lengths can be specified.

- 1) Read the barcode to enable either Max. /Min. Length qualification or Fixed Length(s) qualification.

*Enable Max./Min.
Length (1~127)...



100613

Enable Fixed
Length(s)...



100612

- 2) Read the barcode for Max. Length or Fixed Length 1, and follow steps 3~4.
Repeat steps 2~4 for Min. Length or Fixed Length 2.

Max. Length (*127) or
Fixed Length 1



100614

Min. Length (*4) or
Fixed Length 2



100615

- 3) Read the "[Decimal Value](#)" barcode on page 253 for the desired length.
- 4) Read the "Validate" barcode on the same page to complete this setting.



3.13 French Pharmacode

Enable



*Disable



3.13.1 Transmit Check Digit

Decide whether to include the check digit in the data being transmitted.

*Transmit
French Pharmacode
Check Digit



Do Not Transmit



3.14 Italian Pharmacode

Enable



*Disable



3.14.1 Transmit Check Digit

Decide whether to include the check digit in the data being transmitted.

*Transmit
Italian Pharmacode
Check Digit



Do Not Transmit



3.15 Plessey

Enable



100347

*Disable



100346

3.15.1 Convert to UK Plessey

Decide whether to change each occurrence of the character 'A' to character 'X' in the decoded data.

Convert to UK Plessey



100447

*Do Not Convert



100446

3.15.2 Transmit Check Digit

Decide whether to include the two check digits in the data being transmitted.

*Transmit Plessey
Check Digits



100445

Do Not Transmit



100444



3.16 GS1 DataBar (RSS Family)

It is categorized into three groups:

Group I – GS1 DataBar Omnidirectional (RSS-14)

This group consists of the following:

- ▶ GS1 DataBar Omnidirectional
- ▶ GS1 DataBar Truncated
- ▶ GS1 DataBar Stacked
- ▶ GS1 DataBar Stacked Omnidirectional

Group II – GS1 DataBar Expanded (RSS Expanded)

This group consists of the following:

- ▶ GS1 DataBar Expanded
- ▶ GS1 DataBar Expanded Stacked

Group III – GS1 DataBar Limited (RSS Limited)

This group consists of the following:

- ▶ GS1 DataBar Limited

3.16.1 Select Code ID

Select a desired Code ID to use:

- ▶ “]e0” (GS1 DataBar Code ID)
- ▶ “]c1” (GS1-128 Code ID)

Use “]c1”



100517



*Use “]e0”



100516



3.16.2 GS1 DataBar Omnidirectional (RSS-14)



<p>*Enable RSS-14 & RSS Expanded (Groups I, II)</p>	 100349
<p>Disable</p>	 100348

The settings below apply to Group I symbologies only:

- ▶ GS1 DataBar Omnidirectional
- ▶ GS1 DataBar Truncated



Transmit Code ID

Decide whether to include the Code ID in the data being transmitted.

<p>Transmit RSS-14 Code ID</p>	 100523
<p>*Do Not Transmit</p>	 100522



Transmit Application ID

Decide whether to include the Application ID ("01") in the data being transmitted.

<p>*Transmit RSS-14 Application ID</p>	 100529
<p>Do Not Transmit</p>	 100528

Transmit Check Digit

Decide whether to include the check digit in the data being transmitted.

<p>*Transmit RSS-14 Check Digit</p>	 100481
<p>Do Not Transmit</p>	 100480



3.16.3 GS1 DataBar Expanded (RSS Expanded)

***Enable RSS-14 &
RSS Expanded
(Groups I, II)**



Disable



The settings below apply to Group II symbologies only:

- ▶ GS1 DataBar Expanded

Transmit Code ID

Decide whether to include the Code ID in the data being transmitted.

**Transmit
RSS Expanded Code ID**



***Do Not Transmit**



3.16.4 GS1 DataBar Limited (RSS Limited)

***Enable RSS Limited
(Group III)**



Disable



Transmit Code ID

Decide whether to include the Code ID in the data being transmitted.

**Transmit
RSS Limited Code ID**



***Do Not Transmit**



Transmit Application ID

Decide whether to include the Application ID ("01") in the data being transmitted.

***Transmit
RSS Limited
Application ID**



Do Not Transmit



Transmit Check Digit

Decide whether to include the check digit in the data being transmitted.

***Transmit
RSS Limited
Check Digit**



Do Not Transmit



3.16.5 Field Separator (GS Character)

Decide whether to apply a field separator (to convert the GS control character to human readable character).

Enable Field Separator...



- 1) Read the barcode above to enable field separator.
- 2) Read the "[Hexadecimal System](#)" barcode on page 254 for the desired character string.
- 3) Read the "Validate" barcode to complete this setting.

3.16.6 GS1 Formatting

Decide whether to enable GS1 formatting for GS1 DataBar (RSS family).

Enable



*Disable



3.16.7 Application ID Mark

Decide whether to add an application ID mark (1 character) to the left (AIMark1) or right (AIMark2) of an application ID (AI) for the purpose of labeling it when formatting the GS1 data.

AIMark1



AIMark2



- 1) Read the barcode above to add a mark to the left (AIMark1)/right (AIMark2) of an application ID.
- 2) Read the "[Hexadecimal System](#)" barcode on page 254 for the desired character. Read '00' if you want to remove the AI mark.
- 3) Read the "Validate" barcode to complete this setting.



3.16.8 GS1 DataBar Security Level

Security Level renders more decoding accuracy giving consideration to barcodes' print quality. Decide the security level for reading GS1 DataBar barcodes.

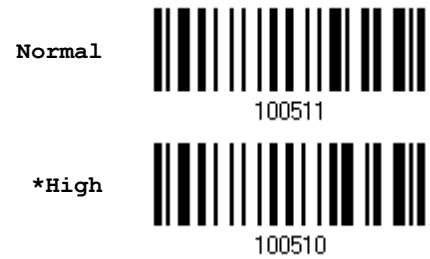

3.17 Telepen

Enable Telepen



100353

*Disable



100352

3.17.1 Telepen Output ASCII/Numeric

Decide whether to support Telepen in full ASCII code. By default, it supports ASCII mode.

- ▶ AIM Telepen (Full ASCII) includes all the alphanumeric and special characters.

Original Telepen
(Numeric)



100485

*AIM Telepen



100484



3.18 UPC-A

UPC-A

***Enable UPC-A
(No Addon)**



100339

Disable



100338

UPC-A Addon 2

Enable UPC-A Addon 2



100341

***Disable**



100340

UPC-A Addon 5

Enable UPC-A Addon 5



100343

***Disable**



100342



Update

3.18.1 Convert to EAN-13

Decide whether to expand the read UPC-A barcode, as well as its addons, into EAN-13.

- ▶ After conversion, the data follows EAN-13 format and is affected by EAN-13 programming selections (e.g. Check Digit).

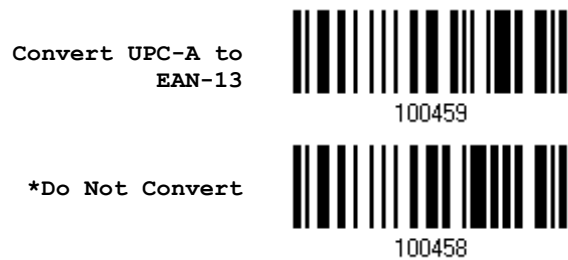

3.18.2 Transmit System Number

Decide whether to include the system number in the data being transmitted.

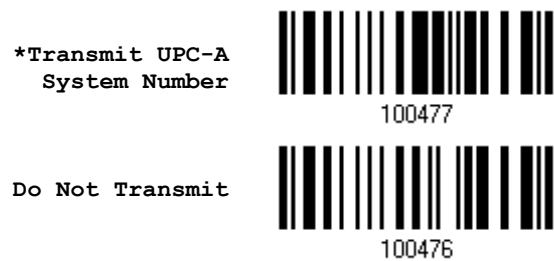

3.18.3 Transmit Check Digit

Decide whether to include the check digit in the data being transmitted.

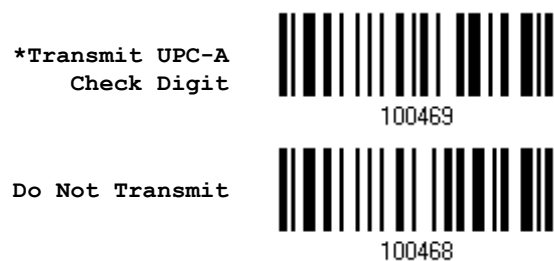

3.19 UPC-E

UPC-E

***Enable UPC-E
(No Addon)**



Disable



UPC-E Addon 2

Enable UPC-E Addon 2



***Disable**



UPC-E Addon 5

Enable UPC-E Addon 5



***Disable**



3.19.1 Select System Number

Decide whether to decode the ordinary UPC-E barcodes only or both UPC-E0 and UPC-E1 barcodes.

- ▶ System number 0 enabled for decoding UPC-E0 barcodes.
- ▶ System number 1 enabled for decoding UPC-E1 barcodes.

System Number 0 & 1



***System Number 0 Only**



Warning: Because of the way system number 1 is encoded, if both system numbers are enabled, the user might suffer from short scanning UPC-A or EAN-13 barcodes into UPC-E1 barcodes.

3.19.2 Convert to UPC-A

Decide whether to expand the read UPC-E barcode, as well as its addons, into UPC-A.

- ▶ After conversion, the data follows UPC-A format and is affected by UPC-A programming selections (e.g. System Number, Check Digit).

Convert UPC-E to
UPC-A



*Do Not Convert



3.19.3 Transmit System Number

Decide whether to include the system number in the data being transmitted.

Transmit UPC-E
System Number



*Do Not Transmit



3.19.4 Transmit Check Digit

Decide whether to include the check digit in the data being transmitted.

*Transmit UPC-E
Check Digit



Do Not Transmit



3.20 Code 11

Enable



100359

*Disable



100358

3.20.1 Verify Check Digit

Select one of the verification when decoding barcodes. If incorrect, the barcode will not be accepted.

None



100538

Double



100537

Single



100536

*Auto



100535

3.20.2 Transmit Check Digit

Decide whether to include the check digit in the data being transmitted.

*Transmit Check
Digit



100542

Do Not Transmit



100541



3.20.3 Security Level

Security Level renders more decoding accuracy giving consideration to barcodes' print quality. Decide the security level for reading Code 11 barcodes.

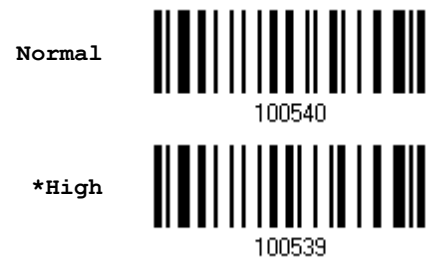

3.20.4 Code Length Qualification

To prevent the "short scan" error, define the "Length Qualification" settings to ensure that the correct barcode is read by qualifying the allowable code length.

- ▶ If "Max/Min Length" is selected, the maximum length and the minimum length must be specified. It only accepts those barcodes with lengths that fall between max/min lengths specified.
- ▶ If "Fixed Length" is selected, up to 2 fixed lengths can be specified.

Note: The specified length(s) must include the check digit(s) the barcode contains.

- 1) Read the barcode to enable either Max. /Min. Length qualification or Fixed Length(s) qualification.

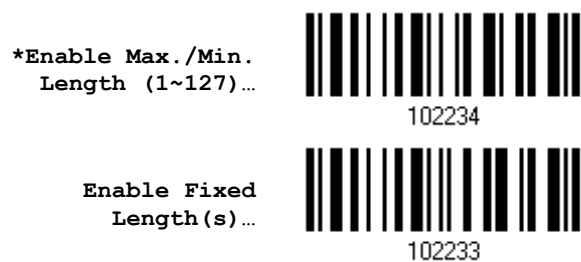

- 2) Read the barcode for Max. Length or Fixed Length 1, and follow steps 3~4. Repeat steps 2~4 for Min. Length or Fixed Length 2.
- 3) Read the "[Decimal Value](#)" barcode on page 253 for the desired length.



Max. Length (*127) or
Fixed Length 1



102235

Min. Length (*4) or
Fixed Length 2



102236

- 4) Read the "Validate" barcode on the same page to complete this setting.



3.21 Composite Code

3.21.1 Composite CC-A/B

Decide whether to enable Composite CC-A/B.

Enable Composite
CC-A/B



102009

*Disable



102008

Decide whether to enable GS1 formatting for Composite CC-A/B. When enabled, the field separator and application ID mark will be automatically added to the output data.

Enable



101492

*Disable



101491

3.21.2 Composite CC-C

Decide whether to enable Composite CC-C.

Enable Composite
CC-C



102011

*Disable



102010

Decide whether to enable GS1 formatting for Composite CC-C.

Enable



101494

*Disable



101493



3.21.3 UPC Composite mode

UPC barcodes can be “linked” with a 2D barcode during transmission as if they were one barcode.

- ▶ **UPC Never Linked**
Transmit UPC barcodes regardless of whether a 2D barcode is detected.
- ▶ **UPC Always Linked**
Transmit UPC barcodes and the 2D portion. If the 2D portion is not detected, the UPC barcode will not be transmitted.

Note: CC-A/B or CC-C must be enabled!

- ▶ **Auto-discriminate UPC Composites**
Transmit UPC barcodes as well as the 2D portion if present.



3.22 2D Symbologies

3.22.1 PDF417

***Enable PDF417**



102033

Disable



102032

3.22.2 MicroPDF417

Decide whether to enable MicroPDF417 barcodes.

Enable MicroPDF417



102035

***Disable**



102034

3.22.3 Data Matrix

Decide whether to enable Data Matrix barcodes.

***Enable Data Matrix**



102037

Disable



102036

Data Matrix Mirror

Decide whether to decode mirror image Data Matrix barcodes.

- ▶ Never — do not decode Data Matrix barcodes that are mirror images.
- ▶ Always — decode only Data matrix barcodes that are mirror images.
- ▶ Auto — decode both mirrored and unmirrored Data Matrix barcodes.





Data Matrix Inverse

Decide whether to decode inverse Data Matrix barcodes.



GS1 Formatting

Decide whether to enable GS1 formatting for GS1-Data Matrix barcodes. When enabled, the field separator and application ID mark will be automatically added to the output data.



Field Separator

Decide whether to apply a field separator (to convert the GS control character to human readable character). The field separator is automatically added to the data when GS1 formatting is enabled.



Specify Field
Separator...



- 1) Read the barcode above to enable field separator.
- 2) Read the "[Hexadecimal System](#)" barcode on page 254 for the desired character string.
- 3) Read the "Validate" barcode to complete this setting.

Application ID Mark

Decide whether to add an application ID mark (1 character) to the left (AIMark1) or right (AIMark2) of an application ID (AI) for the purpose of labeling it when formatting the GS1 data.

AIMark1



AIMark2



- 1) Read the barcode above to add a mark to the left (AIMark1)/right (AIMark2) of an application ID.
- 2) Read the "[Hexadecimal System](#)" barcode on page 254 for the desired character.
- 3) Read '00' if you want to remove the AI mark. Read the "Validate" barcode to complete this setting.

ECI Information

Users can determine whether to show the embedded ECI information when scanning a barcode.

Enable



*Disable



3.22.4 QR Code/MicroQR

Enabling QR Code will enable MicroQR; once QR Code is disabled, MicroQR is then disabled.

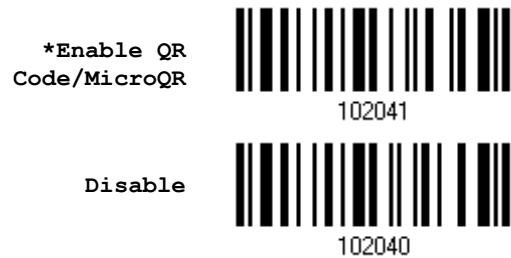

QR Code Mirror

Decide whether to decode mirror image QR Code barcodes.

- ▶ Never — do not decode QR Code barcodes that are mirror images.
- ▶ Always — decode only QR Code barcodes that are mirror images.
- ▶ Auto — decode both mirrored and unmirrored QR Code barcodes.



QR Code Inverse

Decide whether to decode inverse QR Code barcodes.

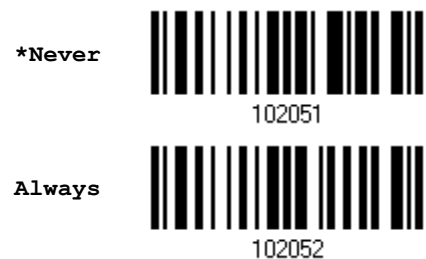



GS1 Formatting

Decide whether to enable GS1 formatting for GS1-QR Code barcodes. When enabled, the field separator and application ID mark will be automatically added to the output data.

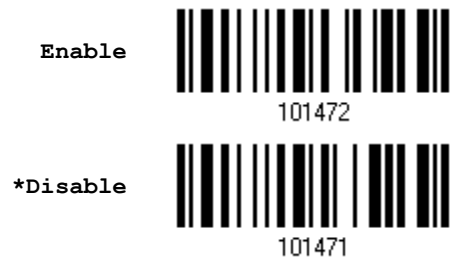

Field Separator

Decide whether to apply a field separator (to convert the GS control character to human readable character). The field separator is automatically added to the data when GS1 formatting is enabled.



- 1) Read the barcode above to enable field separator.
- 2) Read the "[Hexadecimal System](#)" barcode on page 254 for the desired character string.
- 3) Read the "Validate" barcode to complete this setting.

Application ID Mark

Decide whether to add an application ID mark (1 character) to the left (AIMark1) or right (AIMark2) of an application ID (AI) for the purpose of labeling it when formatting the GS1 data.



- 1) Read the barcode above to add a mark to the left (AIMark1)/right (AIMark2) of an application ID.



- 2) Read the "[Hexadecimal System](#)" barcode on page 254 for the desired character. Read '00' if you want to remove the AI mark.
- 3) Read the "Validate" barcode to complete this setting.

3.22.5 Maxicode

***Enable Maxicode**



Disable



3.22.6 Aztec

***Enable Aztec**



Disable



Aztec Mirror

Decide whether to decode mirror image Aztec barcodes.

- ▶ Never — do not decode Aztec barcodes that are mirror images.
- ▶ Always — decode only Aztec barcodes that are mirror images.
- ▶ Auto — decode both mirrored and unmirrored Aztec barcodes.

***Never**



Always



Auto



Aztec Inverse

Decide whether to decode inverse Aztec barcodes.

***Never**



Always



Auto



3.22.7 Han Xin

Enable Han Xin



***Disable**



Defining Output Format

Users can configure the data output format in which the collected data will be output to the host computer. Barcodes read by the scanner will be processed in the following sequence –

- 1) Perform character substitution on the data scanned.
- 2) Add [Code ID](#) and [Length Code](#) to the front of the data: [Code ID] [Length Code] [Data]
- 3) Process the whole data in step 2 with user formats. Data is now divided into fields by user specified rules. Refer to [Chapter 5 Applying Formats for Data Editing](#).
- 4) Add [Prefix Code](#) and [Suffix Code](#) before transmission: [Prefix Code] [Processed Data] [Suffix Code]

In This Chapter

4.1 Letter Case	135
4.2 Character Substitution	136
4.3 Prefix/Suffix Code	148
4.4 Code ID	149
4.5 Length Code.....	156
4.6 Multi-Barcode Editor.....	161
4.7 Removal of Special Character	166

4.1 Letter Case

By default, the alphabets transmission is case-sensitive, meaning that the alphabets will be transmitted according to their original case. Ignoring the original letter case, select [Upper Case] to output data in upper case only; otherwise, select [Lower Case] to output data in lower case only.

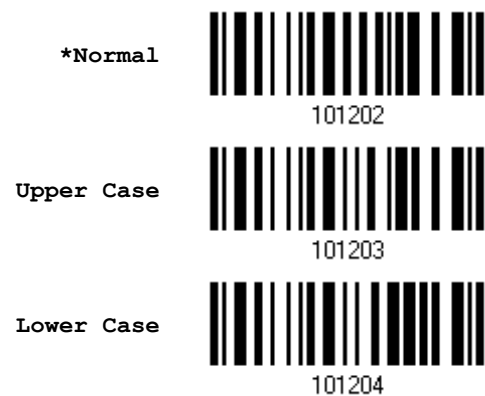

4.2 Character Substitution

Character substitution is performed on every occurrence of the first character specified. If only one character is specified, each time the character occurs in the barcode will be taken away.

- ▶ The first character will be replaced by the second character(s).
- ▶ Up to three sets of character substitution can be configured.
- ▶ If “Keyboard Wedge” or “USB HID” is configured for interface, [Key Type](#) and [Key Status](#) will then become applicable. You may decide whether to apply Key Status when “Normal Key” is selected for Key Type.

Key Type		Key Status
Scan Code	Only 1 scan code value is allowed. Refer to 4.2.1 Single Character Substitution .	N/A
Normal Key	Up to 3 character strings are allowed.	<ul style="list-style-type: none"> ▶ Add Shift ▶ Add Left Ctrl ▶ Add Left Alt ▶ Add Right Ctrl ▶ Add Right Alt Refer to Keyboard Wedge Table .

Note: The character substitution is performed only on the barcode itself and before the processing of editing formats. It is not applicable to the Prefix/Suffix Code, Code ID, Length Code, or any Additional Field.



4.2.1 Single Character Substitution

Please follow steps below to replace a single character with one or more characters.

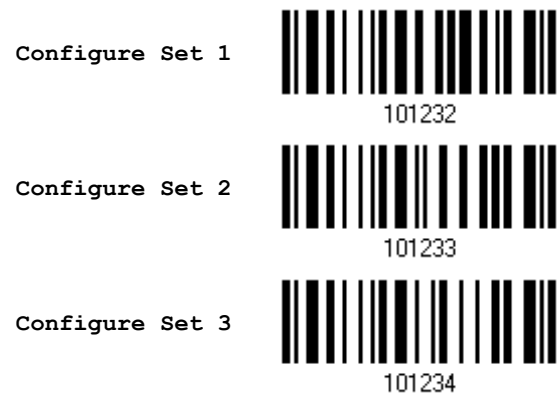

- 1) Read the barcode above to enable character substitution by set.
For example, have the scanner read the "Set 1" barcode to configure the first set of character substitution. The scanner will respond with one short beep, high tone, to indicate more setup barcodes are required.
- 2) Read the "[Hexadecimal Value](#)" barcode on page 254 for the desired character substitution. The first character specified is the target one to be replaced; then the character(s) specified after the first one will be the replacement character(s). For example,

KEY TYPE = NORMAL

- ▶ Read "3", "0", "2", and "D" to replace the character "0" with a dash "-".
- ▶ Read "3", "0", "2", "D", "3", and "0" to replace the character "0" with a dash "-0".

KEY TYPE = SCAN CODE

Replace the character "0" with "a" (= "1C" on the scan code table):

1. Read "3" and "0".
2. Read the "Scan Code" barcode.
3. Read "1" and "C".

KEY TYPE = NORMAL + KEY STATUS = SHIFT

Replace the character "0" with "!" (= "Shift" + "1" on keyboard):

1. Read "3" and "0".
2. Read the "Add Shift" barcode.
3. Read "3" and "1".

- 3) Read the "Validate" barcode to complete this setting. (The defined set or sets will be applied to all symbologies by default.)



4.2.2 Multiple Characters Substitution

Users can replace a string up to 16 characters with another one.

Configure Set 1



Configure Set 2



Configure Set 3



Please follow steps below:

- 1) Respectively read the "Target String" and "Replacement String" barcodes above to enable string substitution by set.
 For example, have the scanner read the "Target String" barcode of "Set 1" to specify the target characters to be replaced. Then the scanner will respond with one short beep indicating users to proceed with barcode reading for target characters.
 Read the "[Hexadecimal Value](#)" barcode on page 254 for the desired characters.
- 2) After specifying the target characters, have the scanner read the "Replacement String" barcode of "Set 1" to specify the replacement characters. Read the "[Hexadecimal Value](#)" barcode on page 254 for the desired characters. For example,



KEY TYPE = NORMAL

Replace the character "0-0" with "****":

1. Read the Target String barcode.
2. Read "3", "0", "2", "D", "3", and "0" barcodes to specify the target string "0-0" (zero, dash, zero).
3. Read the Replacement String barcode.
4. Read "2", "A", "2", "A", "2", and "A" barcodes to specify the replacement string "****" (stars).

KEY TYPE = SCAN CODE

Replace the character "0-0" with "****" ("*" = "3E" on the scan code table):

1. Read the Target String barcode.
2. Read "3", "0", "2", "D", "3", and "0" barcodes to specify the target string "0-0" (zero, dash, zero).
3. Read the Replacement String barcode.
4. Read the "Scan Code" barcode.
5. Read "3", "E", "3", "E", "3", and "E" barcodes to specify the replacement string "****" (stars).

KEY TYPE = NORMAL + KEY STATUS = SHIFT

Replace the character "0-0" with "!!!" ("!" = "Shift" + "1" on keyboard):

1. Read the Target String barcode.
 2. Read "3", "0", "2", "D", "3", and "0" barcodes to specify the target string "0-0" (zero, dash, zero).
 3. Read the Replacement String barcode.
 4. Read the "Add Shift" barcode.
 5. Read "3", "1", "3", "1", "3", and "1".
- 3) Read the "Validate" barcode to complete this setting. (The defined set or sets will be applied to all symbologies by default.)



4.2.3 Symbologies for Character Substitution (All 3 Sets)

By default character substitution will be performed on all symbologies. If the character substitution is not desired with one or more symbologies, read the "Do Not Apply" barcode for each undesired symbologies and all the three sets will be ignored for them.

Character Substitution for Codabar

***Apply**



101253

Do Not Apply



101252

Character Substitution for Code 39

***Apply**



101241

Do Not Apply



101240

Character Substitution for Code 93

***Apply**



101255

Do Not Apply



101254

Character Substitution for Code 128

***Apply**



101257

Do Not Apply



101256



Character Substitution for GS1-128

***Apply**

101259

Do Not Apply

101258

Character Substitution for ISBT 128

***Apply**

101293

Do Not Apply

101292

Character Substitution for EAN-8 (No Addon)

***Apply**

101267

Do Not Apply

101266

Character Substitution for EAN-8 Addon 2

***Apply**

101269

Do Not Apply

101268

Character Substitution for EAN-8 Addon 5

***Apply**

101271

Do Not Apply

101270



Character Substitution for EAN-13 (No Addon)

***Apply**



101273

Do Not Apply



101272

Character Substitution for EAN-13 Addon 2

***Apply**



101275

Do Not Apply



101274

Character Substitution for EAN-13 Addon 5

***Apply**



101277

Do Not Apply



101276

Character Substitution for French Pharmacode

***Apply**



101245

Do Not Apply



101244

Character Substitution for Italian Pharmacode

***Apply**



101243

Do Not Apply



101242



Character Substitution for Industrial 25

***Apply**



101247

Do Not Apply



101246

Character Substitution for Interleaved 25

***Apply**



101249

Do Not Apply



101248

Character Substitution for Matrix 25

***Apply**



101251

Do Not Apply



101250

Character Substitution for MSI

***Apply**



101285

Do Not Apply



101284

Character Substitution for Plessey

***Apply**



101287

Do Not Apply



101286



Character Substitution for GS1 DataBar

*Apply



101291

Do Not Apply



101290

Character Substitution for Telepen

*Apply



101289

Do Not Apply



101288

Character Substitution for UPC-A (No Addon)

*Apply



101279

Do Not Apply



101278

Character Substitution for UPC-A Addon 2

*Apply



101281

Do Not Apply



101280

Character Substitution for UPC-A Addon 5

*Apply



101283

Do Not Apply



101282



Character Substitution for UPC-E (No Addon)

***Apply**



101261

Do Not Apply



101260

Character Substitution for UPC-E Addon 2

***Apply**



101263

Do Not Apply



101262

Character Substitution for UPC-E Addon 5

***Apply**



101265

Do Not Apply



101264

Character Substitution for Code 11

***Apply**



101297

Do Not Apply



101296

Character Substitution for Comoposite CC-A/B

***Apply**



102611

Do Not Apply



102610



Character Substitution for Comopsite CC-C

***Apply**



102613

Do Not Apply



102612

Character Substitution for PDF417

***Apply**



102635

Do Not Apply



102634

Character Substitution for MicroPDF417

***Apply**



102637

Do Not Apply



102636

Character Substitution for Data Matrix

***Apply**



102639

Do Not Apply



102638

Character Substitution for Maxicode

***Apply**



102641

Do Not Apply



102640



Character Substitution for QR Code

***Apply**

102643

Do Not Apply

102642

Character Substitution for MicroQR

***Apply**

102645

Do Not Apply

102644

Character Substitution for Aztec

***Apply**

102647

Do Not Apply

102646

Character Substitution for Han Xin

***Apply**

102649

Do Not Apply

102648



4.3 Prefix/Suffix Code

By default, there is no prefix code, and [ENTER] or [CR] (Carriage Return) is configured to be suffix code. Up to 8 characters can be configured, for example, "Barcode_", and you will have the string appear in front of the barcode read, like this - "Barcode_1234567890".

- ▶ If "Keyboard Wedge" or "USB HID" is configured for interface, [Key Type](#) and [Key Status](#) will then become applicable. You may decide whether to apply Key Status when "Normal Key" is selected for Key Type.

Key Type		Key Status
Scan Code	Up to 4 scan code values are allowed.	N/A
Normal Key	Up to 8 character strings are allowed.	<ul style="list-style-type: none"> ▶ Add Shift ▶ Add Left Ctrl ▶ Add Left Alt ▶ Add Right Ctrl ▶ Add Right Alt Refer to Keyboard Wedge Table .

Configure Prefix



Configure Suffix



- 1) Read the barcode above to apply prefix code or suffix code separately, and follow steps 2~3. (Max. 8 characters each)
- 2) Read the "[Hexadecimal Value](#)" barcode on page 254 for the desired character string. For example, read "2" and "B" for the scanner to prefix or suffix the character [+].
- 3) Read the "Validate" barcode to complete this setting.



4.4 Code ID

Up to two characters for Code ID can be configured for each symbology. To make the Code ID configuration easier, the scanner provides five pre-defined Code ID sets from which you can select one and make necessary changes on it.

- ▶ If "Keyboard Wedge" or "USB HID" is configured for interface, [Key Type](#) and [Key Status](#) will then become applicable. You may decide whether to apply Key Status when "Normal Key" is selected for Key Type.

Key Type		Key Status
Scan Code	Only 1 scan code value is allowed.	N/A
Normal Key	Up to 2 character strings are allowed.	<ul style="list-style-type: none"> ▶ Add Shift ▶ Add Left Ctrl ▶ Add Left Alt ▶ Add Right Ctrl ▶ Add Right Alt Refer to Keyboard Wedge Table .

Note: "]C1" is the Code ID of GS1-128 (EAN-128) barcodes; "]e0" is the default Code ID of GS1 DataBar (RSS) barcodes.

4.4.1 Select Pre-defined Code ID

Apply Code ID Set 1	
	109961
Apply Code ID Set 2	
	109962
Apply Code ID Set 3	
	109963
Apply Code ID Set 4	
	109964
Apply Code ID Set 5	
	109965



Code ID options	Set 1	Set 2	Set 3	Set 4	Set 5
Code 39	A	C	Y	M	A
Italian Pharmacode	A	C	Y	M	A
French Pharmacode	A	C	Y	M	A
Industrial 25	C	H	H	H	S
Interleaved 25	D	I	Z	I	S
Matrix 25	E	G	G	G	S
Codabar	F	N	X	N	F
Code 93	I	L	L	L	G
Code 128	H	K	K	K	C
ISBT 128	H	K	K	K	C
UPC-E	S	E	C	E	E
EAN-8	P	B	B	FF	E
EAN-13	M	A	A	F	E
UPC-A	J	A	A	A	E
MSI	V	V	D	P	M
Plessey	W	W	E	Q	P
Telepen	Z	---	---	---	---
Code 11	K	J	J	D	H
Composite CC-A/B	L	X	M	J	La
Composite CC-C	N	Y	N	O	Lc
PDF417	a	O	W	T	L
MicroPDF417	b	P	V	U	L
Data Matrix	c	Q	U	V	d
QR Code	e	S	S	X	Q
MicroQR	f	T	R	Y	Q
Maxicode	d	R	T	W	U
Aztec	g	U	Q	Z	z
Han Xin	r	k	c	s	X

Besides Set 1 ~ 5 of Code ID options, you can also scan the barcode below to apply AIM Code ID as the Code ID option.

Enable AIM Code ID



*Disable AIM Code ID



102269

After applying AIM Code ID, three characters are added in front of the output data. “]” is always the first character. The second (Character) and third (Modifier Character) may vary depending on symbologies. Please refer to the table below.

Symbology	Character	Modifier Character
Codabar	F	0: Standard Codabar symbol. No special processing.
Code 11	H	0: Single modulo 11 check character validated and transmitted 1: Two modulo 11 check characters validated and transmitted 3: Check characters validated but not transmitted ?: No check character validation
Code 39	A	0: No check character validation nor full ASCII processing. All data transmitted as decoded. 1: Modulo 43 check character validated and transmitted 3: Modulo 43 check character validated but not transmitted 4: Full ASCII character conversion performed. No check character validation. 5: Full ASCII character conversion performed. Modulo 43 check character validated and transmitted. 7: Full ASCII character conversion performed. Modulo 43 check character validated but not transmitted.
Code 93	G	No options specified. Always transmit 0.
Code 128	C	0: Standard data packet. No FNC1 in first or second symbol character position after start character. 1: EAN/UCC-128 data packet. FNC1 in first symbol character position after start character. 2: FNC1 in second symbol character position after start character. 4: Concatenation according to International Society for Blood Transfusion specifications has been performed. Concatenated data follows.
GS1 DataBar Family	e	No option specified at this time. Always transmit 0. GS1 DataBar and GS1 DataBar Limited transmit with an Application Identifier “01”.
Interleaved 25	I	0: No check character validation 1: Modulo 10 symbol check character validated and transmitted 3: Modulo 10 symbol check character validated but not transmitted
MSI	M	0: Modulo 10 symbol check character validated and transmitted 1: Modulo 10 symbol check character validated but not transmitted
Matrix 25	X	No options specified. Always transmit 0.













Plessey	P	No options specified. Always transmit 0.
Industrial 25	S	No options specified. Always transmit 0.
Telepen	B	No options specified. Always transmit 0.
UPC/EAN	E	0: Standard data packet in full EAN format (13 digits for EAN-13, UPC-A, and UPC-E; does not include add-on data) 3: Combined data packet comprising 13 digits from EAN-13, UPC-A, or UPC-E symbol and 2 or 5 digits from add-on symbol 4: EAN-8 data packet
DataMatrix	d	1: ECC 200
Aztec	z	0: Aztec symbol C: Aztec Rune symbol
Maxicode	U	0: Symbol in Mode 4 or 5 1: Symbol in Mode 2 or 3
PDF417/Micro PDF417	L	2: Reader set to follow protocol of ENV 12925 for Extended Channel Interpretation
QR/Micro QR	Q	1: Model 2 symbol, ECI protocol not implemented
Han Xin	h	0: Generic data, no special features are set. The transmitted data does not follow the AIM ECI protocol.















4.4.2 Change Code ID







- 1) Read the barcode below to change code ID of a specific symbology.
- 2) Read the "[Hexadecimal Value](#)" barcode on page 254 for the desired character string. For example, read "4" and "4" for applying the character [D] for Code ID.
- 3) Read the "Validate" barcode to complete this setting.

Configure Code ID for Codabar	 101456
Configure Code ID for Code 39	 101450
Configure Code ID for Code 93	 101457
Configure Code ID for Code 128	 101458
Configure Code ID for ISBT 128	 101466
Configure Code ID for EAN-8	 101460
Configure Code ID for EAN-13	 101461
Configure Code ID for French Pharmacode	 101452
Configure Code ID for Italian Pharmacode	 101451
Configure Code ID for Industrial 25	 101453



Configure Code ID for Interleaved 25	 101454
Configure Code ID for Matrix 25	 101455
Configure Code ID for MSI	 101463
Configure Code ID for Plessey	 101464
Configure Code ID for Telepen	 101465
Configure Code ID for UPC-A	 101462
Configure Code ID for UPC-E	 101459
Configure Code ID for Code 11	 101499
Configure Code ID for Composite CC-A/B	 102568
Configure Code ID for Composite CC-C	 102569
Configure Code ID for PDF417	 102580
Configure Code ID for MicroPDF417	 102581



Configure Code ID for Data Matrix	 102582
Configure Code ID for Maxicode	 102583
Configure Code ID for QR Code	 102584
Configure Code ID for MicroQR	 102585
Configure Code ID for Aztec	 102586
Configure Code ID for Han Xin	 102590

4.4.3 Clear Code ID Settings

Clear All Code ID Settings	 109960
-------------------------------	---



4.5 Length Code

A 4-digit code representing the length of barcode data (character count) can be inserted in front of data being transmitted. Such "Length" code can be individually enabled or disabled for each symbology.

Length Code for Codabar

Apply



101413

*Do Not Apply



101412

Length Code for Code 39

Apply



101401

*Do Not Apply



101400

Length Code for Code 93

Apply



101415

*Do Not Apply



101414

Length Code for Code 128

Apply



101417

*Do Not Apply



101416



Length Code for GS1-128 & GS1 DataBar

Apply



101419

*Do Not Apply



101418

Length Code for ISBT 128

Apply



101435

*Do Not Apply



101434

Length Code for EAN-8

Apply



101423

*Do Not Apply



101422

Length Code for EAN-13

Apply



101425

*Do Not Apply



101424

Length Code for French Pharmacode

Apply



101405

*Do Not Apply



101404



Length Code for Italian Pharmacode

Apply



101403

*Do Not Apply



101402

Length Code for Industrial 25

Apply



101407

*Do Not Apply



101406

Length Code for Interleaved 25

Apply



101409

*Do Not Apply



101408

Length Code for Matrix 25

Apply



101411

*Do Not Apply



101410

Length Code for MSI



102515



102514



Length Code for Pleesey

Apply



101431

*Do Not Apply



101430

Length Code for Telepen

Apply



101433

*Do Not Apply



101432

Length Code for UPC-A

Apply



101427

*Do Not Apply



101426

Length Code for UPC-E

Apply



101421

*Do Not Apply



101420

Length Code for Code 11

Apply



101439

*Do Not Apply



101438



Length Code for Composite CC-A/B

Apply



102509

*Do Not Apply



102508

Length Code for Composite CC-C

Apply



102511

*Do Not Apply



102510

Length Code for PDF417

Apply



102533

*Do Not Apply



102532

Length Code for MicroPDF417

Apply



102535

*Do Not Apply



102534

Length Code for Data Matrix

Apply



102537

*Do Not Apply



102536



Length Code for Maxicode

Apply



102539

*Do Not Apply



102538

Length Code for QR Code

Apply



102541

*Do Not Apply



102540

Length Code for MicroQR

Apply



102543

*Do Not Apply



102542

Length Code for Aztec

Apply



102545

*Do Not Apply



102544

Length Code for Han Xin

Apply



102547

*Do Not Apply



102546



4.6 Multi-Barcode Editor

The Multi-Barcode Editor allows users to decide the output sequence of a concatenation of barcodes. Up to five barcodes can be specified. Enabling this mode will force the scanner to apply Presentation mode as the scan mode. For the scanner to concatenate barcodes, the maximum output data length of all the barcodes is 10 KB after configuration. When the data length exceeds 10 KB, the concatenation will not take effect.

Note: The Multi-Barcode Editor has nothing to do with [1.6.6 Multi-Barcode Mode](#).

The barcodes that are found meeting the specified criteria below will be arranged in the desired sequence.

- ▶ Code Type
- ▶ 4-digit barcode length, excluding prefix, suffix, length code, etc.
- ▶ Matching the first character of barcode data

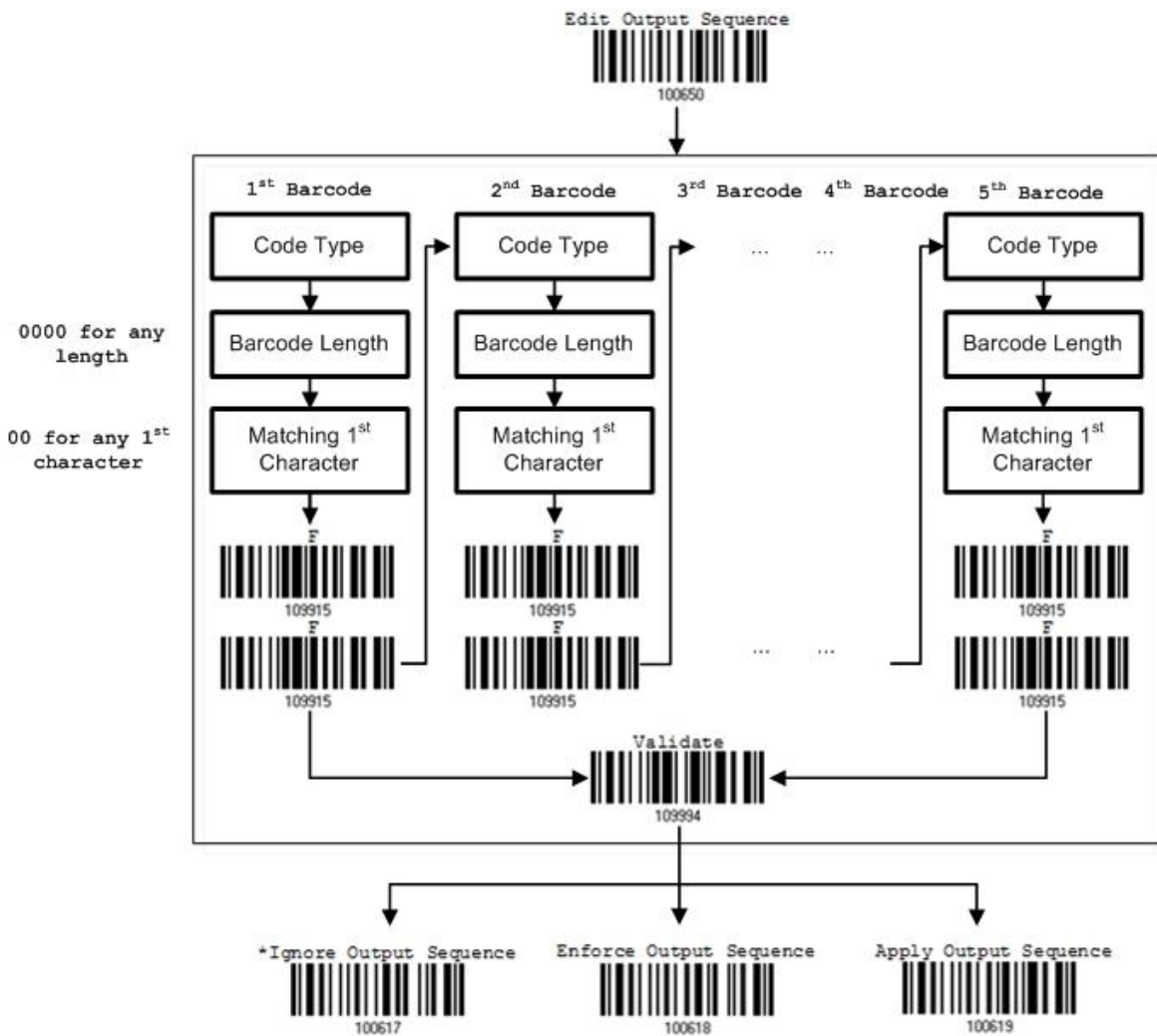

4.6.1 Edit a Concatenation of Barcodes

Edit Output Sequence



- 1) Read the barcode above to start editing a concatenation of barcodes.
- 2) Code Type setting – read the ["Hexadecimal Value"](#) barcode on page 254 for Code Type of the (first) barcode. For example, read "4" and "1" for Code 39.



Code Type	Symbology	Code Type	Symbology
3E (>)	Han Xin		
40 (@)	ISBT 128		
41 (A)	Code 39		
42 (B)	Italian Pharmacode		
43 (C)	French Pharmacode		
44 (D)	Industrial 25		
45 (E)	Interleaved 25		
46 (F)	Matrix 25		
47 (G)	Codabar (NW7)	67 (g)	Code 11
48 (H)	Code 93		
49 (I)	Code 128		
4A (J)	UPC-E0 / UPC-E1	6A (j)	Composite CC-C
4B (K)	UPC-E with Addon 2	6B (k)	PDF417
4C (L)	UPC-E with Addon 5	6C (l)	MicroPDF417
4D (M)	EAN-8	6D (m)	Data Matrix
4E (N)	EAN-8 with Addon 2	6E (n)	Maxicode
4F (O)	EAN-8 with Addon 5	6F (o)	QR Code
50 (P)	EAN-13		
51 (Q)	EAN-13 with Addon 2		
52 (R)	EAN-13 with Addon 5		
53 (S)	MSI		
54 (T)	Plessey		
55 (U)	GS1-128 (EAN-128)		
56 (V)	UPC-A	76 (v)	Composite CC-A/B
57 (W)	UPC-A with Addon 2		
58 (X)	UPC-A with Addon 5		
5A (Z)	Telepen	7A (z)	Aztec
5B ([)	GS1 DataBar (RSS)	7B ({)	Micro QR

- 3) Barcode Length setting – read the “[Decimal Value](#)” barcode on page 253 for the 4-digit length of the (first) barcode. For example, read “0065” for barcode length of 65 characters or read “0000” for any length.



Note: If not reading 0000 for any length, the 4-digit length must exclude prefix, suffix (0x0d by default), length code, etc.

- 4) Matching Character setting – read the “[Hexadecimal Value](#)” barcode on page 254 for the 1st character that must be found matching in the (first) barcode. For example, read “4” and “1” for matching character “A” as the first character in the barcode or read “00” for any character.
- 5) Read twice the “F” barcode on page 254 (“FF”) to complete the setting of each barcode.
- 6) Read the “Validate” barcode to end the editing of the barcode set.

4.6.2 Activate the Concatenation of Barcodes

By default, the output sequence editing of the concatenation of barcodes is not applied.

When “Enforce Output Sequence” is enabled, all barcodes read by the scanner must meet with the criteria for the concatenation. If data is found excluded from all output sequence sets (= not meeting with the criteria), the scanner will not accept the reading, and therefore, data will not be transmitted.

When “Apply Output Sequence” is enabled, only barcodes found meeting with the criteria are counted for the concatenation. Those found not meeting with the criteria are processed normally and individually.

Note: When it requires reading more barcodes to complete the “output sequence” requirements, the scanner will respond with one short beep (low tone). After reading an acceptable barcode, its LED indicator will become solid green and go off quickly (= Good Read).

Upon completion of reading acceptable barcodes, the scanner will respond with one short beep (high tone) and its LED indicator will become solid green and go off quickly (= Good Read).



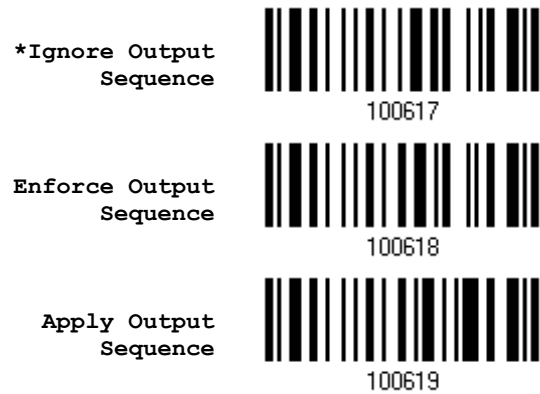

Warning: When you disable the Multi-Barcode Editor later, the scan mode remains unchanged. If Presentation mode is not desired, proceed to select a scan mode best suits the application.

4.7 Removal of Special Character

A single character can be specified only. Every matching character from the starting position of barcode data will be removed until a different character is met. For example, if you specify the character "0" (hex value is "30") to be removed from barcode data, one or more zeros will be stripped off the barcode data "012345" and "00012345". However, for barcode data "010333", only the first zero will be stripped off.



- 1) Read the barcode above to remove the specified character.
- 2) Read the "[Hexadecimal Value](#)" barcode on page 254 for the desired character string. For example, read "3" and "0" for the scanner to remove the character "0".
- 3) Read the "Validate" barcode to complete this setting.



Applying Formats for Data Editing

The scanner allows advanced data editing by applying user-configured editing formats. The whole processed data can be divided into fields by user-specified rules. These fields together with the user-configurable additional fields consist of the data actually sent to the host computer.

To apply any editing format, the maximum output data length of a barcode is 7 KB after configuration. When the data length exceeds 7 KB, editing format will not take effect.

[Prefix Code]	[Code ID]	[Length Code]	[Data]	[Suffix Code]	Additional Field(s)
None by default	None by default	None by default	Barcode itself	0x0d by default	

In This Chapter

5.1 Activating Editing Formats.....	168
5.2 How to Configure Editing Formats	170
5.3 Configuring Format — Define Data Criteria	173
5.4 Configuring Format — Define Data Field.....	184
5.5 Configuring Format — Define Transmission Sequence	192
5.6 Programming Examples	195



5.1 Activating Editing Formats

5.1.1 Activate Editing Formats

Any editing format configured before can directly be applied. If there's not, users must start with configuring an editing format first, and then activate the editing format when it is desired in use.

Editing Format 1

Enable



101301

*Disable



101300

Editing Format 2

Enable



101303

*Disable



101302

Editing Format 3

Enable



101305

*Disable



101304

Editing Format 4

Enable



101307

*Disable



101306



Editing Format 5



5.1.2 Exclusive Data Editing

By default, only barcodes found meeting with the criteria are processed by the editing formats. Those found not meeting with the criteria are processed normally.

When "Exclusive Data Editing" is enabled, all barcodes read by the scanner must be processed by the editing formats. If data is found excluded from all enabled editing formats (= not meeting with the specified criteria), the scanner will not accept the reading, and therefore, data will not be transmitted.



5.2 How to Configure Editing Formats

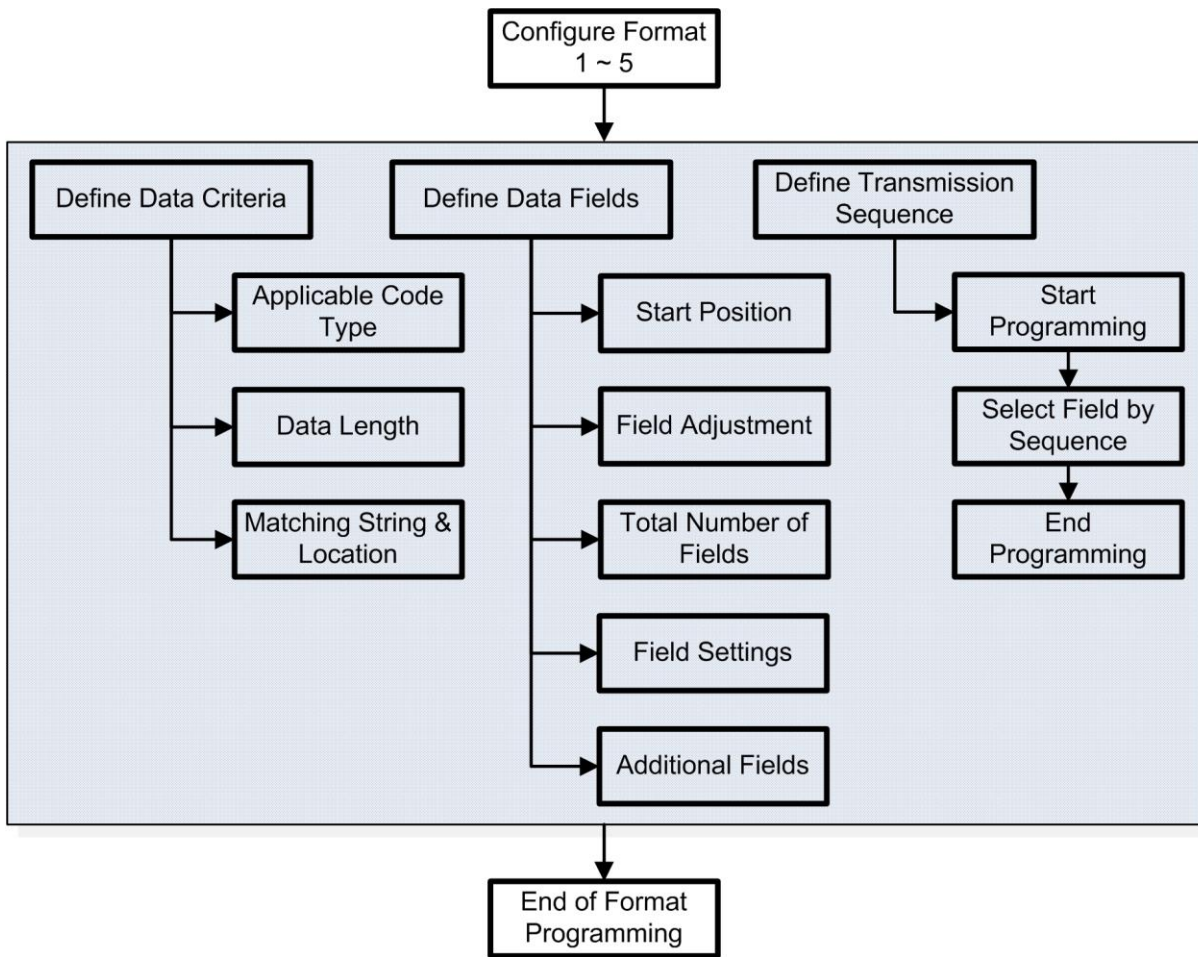

5.2.1 Select Format to Configure

Start Programming Format

Select one editing format (Format 1~5) and the parameters pertaining to the editing format can then be configured – applicable code type, data length, matching string & location, start position, field adjustment, total number of fields, field settings (field-dividing rule), additional fields, and field transmission sequence.

- ▶ Up to five different formats can be specified.

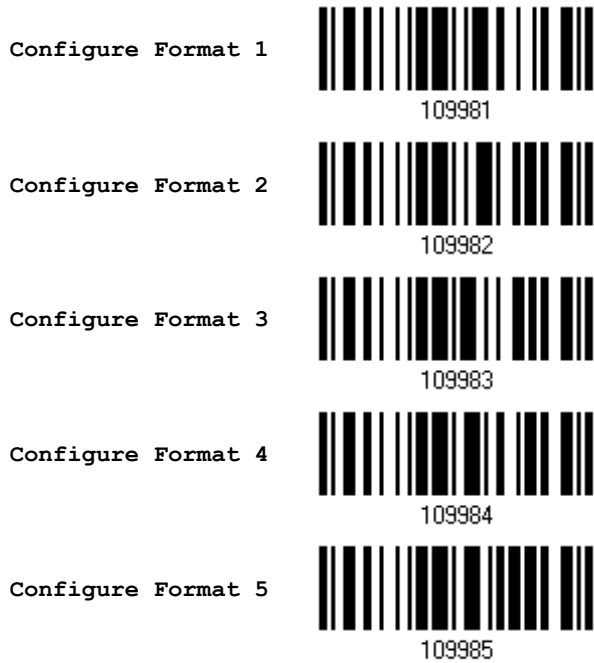

Note: Before completing the programming of an editing format, having the scanner read any barcode for parameters other than those pertaining to the editing format will automatically abort the programming process.

End Programming Format

After configuring all the desired parameters, have the scanner read the “End Programming Format” barcode, which can be located at the bottom of every even page in this chapter.



5.2.2 Restore Default Format

Select an existing editing format and have the defaults restored. The default settings of an editing format are listed below.

Editing format	Defaults
Applicable Code Type	All
Data Length	0 (No qualification)
Matching String	Disable
Matching String Location	None
Start Position	From head
Field Adjustment	No adjustment
Total Number of Fields	1
Field Setting – field-dividing rule	Not configured
Additional Fields	None
Field Transmission Sequence	F1

Restore Default
Format



109990



5.3 Configuring Format – Define Data Criteria

Three applicable conditions can be configured to check whether the data read by the scanner can be processed by the particular editing format.

Note: Data editing cannot be performed unless the three conditions are all met.

5.3.1 Applicable Code Type

By default, barcodes of all the supported symbologies will be processed by any editing format previously configured and enabled. For quick configuration, first clear all, and then select the desired symbologies.

Note: It must have at least one symbology selected.

*Apply to All



Clear All



Editing Format for Codabar

*Apply



101513

Do Not Apply



101512

Editing Format for Code 39

*Apply



101501

Do Not Apply



101500

Editing Format for Code 93

*Apply



101515

Do Not Apply



101514

Editing Format for Code 128

*Apply



101517

Do Not Apply



101516

Editing Format for GS1-128 & GS1 DataBar

*Apply



101519

Do Not Apply



101518



Editing Format for ISBT 128

*Apply



101553

Do Not Apply



101552

Editing Format for EAN-8

*Apply



101527

Do Not Apply



101526

Editing Format for EAN-8 Addon 2

*Apply



101529

Do Not Apply



101528

Editing Format for EAN-8 Addon 5

*Apply



101531

Do Not Apply



101530

Editing Format for EAN-13

*Apply



101533

Do Not Apply



101532



Editing Format for EAN-13 Addon 2

***Apply**



101535

Do Not Apply



101534

Editing Format for EAN-13 Addon 5

***Apply**



101537

Do Not Apply



101536

Editing Format for French Pharmacode

***Apply**



100412

Do Not Apply



101504

Editing Format for Italian Pharmacode

***Apply**



101503

Do Not Apply



101502

Editing Format for Industrial 25

***Apply**



101507

Do Not Apply



101506



Editing Format for Interleaved 25

*Apply



101509

Do Not Apply



101508

Editing Format for Matrix 25

*Apply



101511

Do Not Apply



101510

Editing Format for MSI

*Apply



101545

Do Not Apply



101544

Editing Format for Plessey

*Apply



101547

Do Not Apply



101546

Editing Format for Telepen

*Apply



101549

Do Not Apply



101548



Editing Format for UPC-A

*Apply



101539

Do Not Apply



101538

Editing Format for UPC-A Addon 2

*Apply



101541

Do Not Apply



101540

Editing Format for UPC-A Addon 5

*Apply



101543

Do Not Apply



101542

Editing Format for UPC-E

*Apply



101521

Do Not Apply



101520

Editing Format for UPC-E Addon 2

*Apply



101523

Do Not Apply



101522



Editing Format for UPC-E Addon 5

***Apply**



101525

Do Not Apply



101524

Editing Format for Code 11

***Apply**



101557

Do Not Apply



101556

Editing Format for Composite CC-A/B

***Apply**



101629

Do Not Apply



101628

Editing Format for Composite CC-C

***Apply**



101631

Do Not Apply



101630

Editing Format for PDF417

***Apply**



101653

Do Not Apply



101652



Editing Format for MicroPDF417

***Apply**



101655

Do Not Apply



101654

Editing Format for Data Matrix

***Apply**



101657

Do Not Apply



101656

Editing Format for Maxicode

***Apply**



101659

Do Not Apply



101658

Editing Format for QR Code

***Apply**



101661

Do Not Apply



101660

Editing Format for MicroQR

***Apply**



101663

Do Not Apply



101662



Editing Format for Aztec

*Apply	 101665
Do Not Apply	 101664

Editing Format for Han Xin

*Apply	 101667
Do Not Apply	 101666



5.3.2 Data Length

The length must include prefix, suffix (0x0d by default), length code, etc. By default, barcodes of any length (character count) are eligible for data editing.

- ▶ Specify a value.
- ▶ When zero is given to both, the scanner will not perform the length qualification.

1) Read the barcode below to specify Max. Length or Min. Length separately, and follow steps 2~3.



- 2) Read the "[Decimal Value](#)" barcode on page 253 for the desired length.
- 3) Read the "Validate" barcode on the same page to complete this setting.



5.3.3 Matching String & Location

By default, no matching string is specified, and therefore, it is disabled. Enable this feature by specifying a matching string; up to four characters are allowed.

- ▶ When the Matching String Location is zero, the scanner will only check for the existence of the matching string in the barcode data.
- ▶ Specify a value to indicate where the matching string starts in the barcode data.

1) Read the barcode to specify a matching string.



- 2) Read the "[Hexadecimal Value](#)" barcode on page 254 for the desired character string.
- 3) Read the "Validate" barcode to complete this setting.
- 4) Read the barcode to specify the location of the matching string.

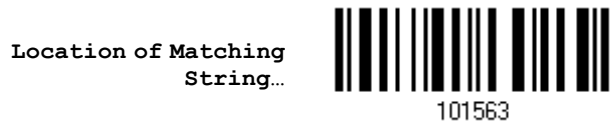

- 5) Read the "[Decimal Value](#)" barcode on page 253 for the desired location.
- 6) Read the "Validate" barcode on the same page to complete this setting.



5.4 Configuring Format – Define Data Field

5.4.1 Start Position

Data can be divided into fields in one of the following direction –

- ▶ from head (F1) to tail (F5)
- ▶ from tail (F1) to head (F5)



5.4.2 Field Adjustment

Apply equal length to all fields, if necessary. If data is found longer than specified, it will be truncated automatically. When data is found shorter, it will add "Space" (0x20) to field.

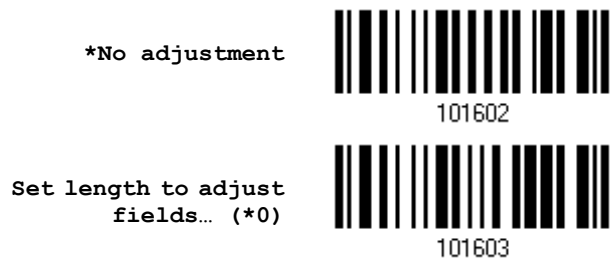

- 1) Read the barcode above to adjust field by length.
- 2) Read the "[Decimal Value](#)" barcode on page 253 for the desired field length.
- 3) Read the "Validate" barcode on the same page to complete this setting.



5.4.3 Total Number of Fields

Data can be divided into at most 6 fields; each of them is numbered from F1 to F6 accordingly. However, only F1~F5 can be configured.

- ▶ The total number of fields must be specified correctly. If three fields are configured for the editing format, the data characters after F3 will be assigned to F4 automatically. This feature is quite useful especially when data of variable lengths is processed by editing formats.

*One Field	
	101590
Two Fields	
	101591
Three Fields	
	101592
Four Fields	
	101593
Five Fields	
	101594
Six Fields	
	101595

Note: The number of configurable fields is always one less than the total number of fields specified. The extra data characters beyond the last field configured will be automatically assigned to the next field.



5.4.4 Field Settings

Data eligible for editing formats is divided into fields by user-specified rules – either using the field terminating string or specified field length.

By Terminating String

Specify the field terminating string. Up to two characters are allowed. The scanner will search for the occurrence of this particular string in the data.

- ▶ By default, this string will be included in the field.

By Length

Alternatively, you may simply specify the field length. The scanner will assign the next specified number of characters into the field.

Field 1 Setting

1. Read the barcode below to divide field 1 by a specified terminating string.

Select
Field Separator
to Divide Field 1...



2. Read the "[Hexadecimal Value](#)" barcode on page 254 for the desired character string.
3. Read the "Validate" barcode to complete this setting.
4. Read the "Discard Separator" barcode if the field separator is not desired in the field.

*Include Separator



Discard Separator



If not dividing the field by a specific separator, you may divide it by a specified length.

1. Read the barcode below to divide field 1 by length.

Divide Field 1
by Length



2. Read the "[Decimal Value](#)" barcode on page 253 for the desired field length.
3. Read the "Validate" barcode on the same page to complete this setting.



Field 2 Setting

1. Read the barcode below to divide field 2 by a specified terminating string.

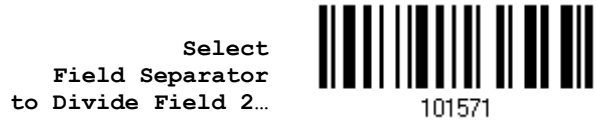

2. Read the "[Hexadecimal Value](#)" barcode on page 254 for the desired character string.
3. Read the "Validate" barcode to complete this setting.
4. Read the "Discard Separator" barcode if the field separator is not desired in the field.



If not dividing the field by a specific separator, you may divide it by a specified length.

1. Read the barcode below to divide field 2 by length.

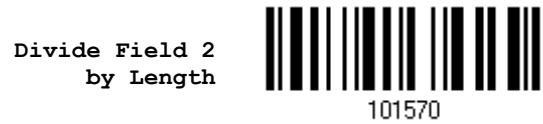

2. Read the "[Decimal Value](#)" barcode on page 253 for the desired field length.
3. Read the "Validate" barcode on the same page to complete this setting.



Field 3 Setting

1. Read the barcode below to divide field 3 by a specified terminating string.

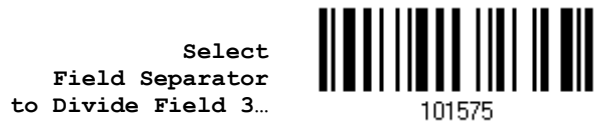

2. Read the "[Hexadecimal Value](#)" barcode on page 254 for the desired character string.
3. Read the "Validate" barcode to complete this setting.
4. Read the "Discard Separator" barcode if the field separator is not desired in the field.



If not dividing the field by a specific separator, you may divide it by a specified length.

1. Read the barcode below to divide field 3 by length.



2. Read the "[Decimal Value](#)" barcode on page 253 for the desired field length.
3. Read the "Validate" barcode on the same page to complete this setting.



Field 4 Setting

1. Read the barcode below to divide field 4 by a specified terminating string.

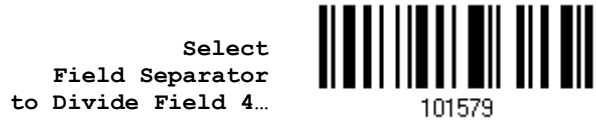

2. Read the "[Hexadecimal Value](#)" barcode on page 254 for the desired character string.
3. Read the "Validate" barcode to complete this setting.
4. Read the "Discard Separator" barcode if the field separator is not desired in the field.



If not dividing the field by a specific separator, you may divide it by a specified length.

1. Read the barcode below to divide field 4 by length.

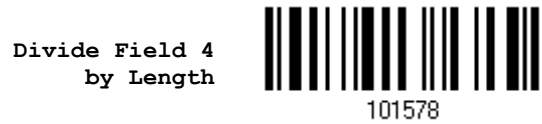

2. Read the "[Decimal Value](#)" barcode on page 253 for the desired field length.
3. Read the "Validate" barcode on the same page to complete this setting.



Field 5 Setting

1. Read the barcode below to divide field 5 by a specified terminating string.

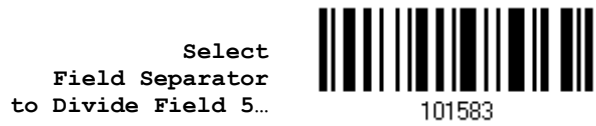

2. Read the "[Hexadecimal Value](#)" barcode on page 254 for the desired character string.
3. Read the "Validate" barcode to complete this setting.
4. Read the "Discard Separator" barcode if the field separator is not desired in the field.



If not dividing the field by a specific separator, you may divide it by a specified length.

1. Read the barcode below to divide field 5 by length.



2. Read the "[Decimal Value](#)" barcode on page 253 for the desired field length.
3. Read the "Validate" barcode on the same page to complete this setting.



Additional Fields

Up to five additional fields can be created for each editing format; each of them is numbered from AF1 to AF5 accordingly.

- ▶ If “Keyboard Wedge” or “USB HID” is configured for interface, Key Type and Key Status will then become applicable. Decide whether to apply Key Status when “Normal Key” is selected for Key Type.

Key Type		Key Status
Scan Code	Up to 2 scan code values are allowed.	N/A
Normal Key	Up to 4 character strings are allowed.	<ul style="list-style-type: none"> ▶ Add Shift ▶ Add Left Ctrl ▶ Add Left Alt ▶ Add Right Ctrl ▶ Add Right Alt Refer to Keyboard Wedge Table .

1. Read the barcode below to specify an additional field, one at a time.

Additional Field 1...	 101584
Additional Field 2...	 101585
Additional Field 3...	 101586
Additional Field 4...	 101587
Additional Field 5...	 101588

2. Read the “[Hexadecimal Value](#)” barcode on page 254 for the desired additional field.
3. Read the “Validate” barcode to complete this setting.



5.4.5 Pause Field Setting

Pause Field Time

Limit the pause time interval (1~16). By default, it is set to 1 second.

Pause Field Time
1~16 sec.
(*1)



1. Read the barcode above to specify the time interval for the Pause Field. (It is set to 1 by default.)
2. Read the "[Decimal Value](#)" barcode on page 253. For example, read "1" and "0" for setting the Pause Field Time to 10 seconds.
3. Read the "Validate" barcode on the same page to complete this setting.



5.5 Configuring Format – Define Transmission Sequence

After configuring the data fields and additional fields, you must now program the transmission sequence of these fields that comprise the final data. This field transmission sequence can be assigned in any desired order and fields can be assigned multiple times as well.

Note: Up to twelve fields can be assigned.

- 1) Read the "Start" barcode to begin with programming the field transmission sequence.

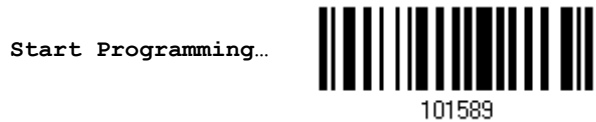

- 2) Program the transmission sequence by reading the desired fields as well as additional fields.



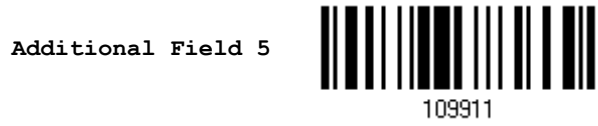
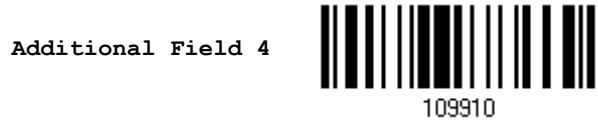
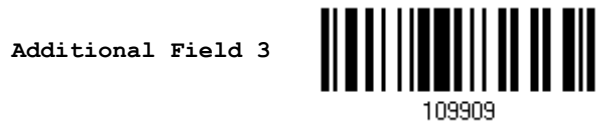
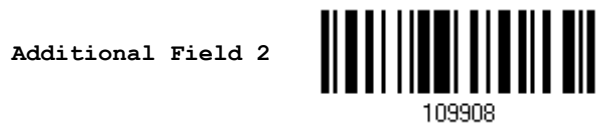

3) Read the "End" barcode to complete this setting.



5.6 Programming Examples

5.6.1 Example I

Extract data from the 10th character to the 19th character...

The editing format should be configured as follows:

1. Read the "Enter Setup" barcode to enter the Configuration Mode.
2. Read the "Configure Format 1" barcode.
3. Read the "Clear All" and "Code 128" barcodes for applicable code type.
4. Read the "Three Fields" barcode.
5. Read the "Divide Field 1 by Length" barcode, and set length to 9.
Field 1 data starts from the 1st character to the 9th character.
6. Read the "Divide Field 2 by Length" barcode, and set length to 10.
Field 2 data starts from the 10th character to the 19th character.
7. Read the "Start (Programming)" barcode to program the transmission sequence.
8. Read the "Field 2" barcode.
9. Read the "End" barcode to complete the transmission sequence setting.
10. Read the "End Programming Format" barcode to complete the setting of Editing Format 1.
11. Read the "Enable Format 1" barcode to apply Editing Format 1 to Code 128.
12. Read the "Update" barcode to exit the Configuration Mode.



5.6.2 Example II

Extract the date code, item number, and quantity information from barcodes.

Data in a barcode is encoded like this:

- ▶ From the 1st character to the 6th character is the date code.
- ▶ From the 7th character to the dash '-' character is the item number.
- ▶ After the dash '-' character is the quantity information.

Data will be transmitted like this:

- ▶ The item number goes first, then a TAB character, followed by the date code, then another TAB character, and finally the quantity information.

The editing format should be configured as follows:

1. Read the "Enter Setup" barcode to enter the Configuration Mode.
2. Read the "Configure Format 2" barcode.
3. Read the "Three Fields" barcode.
4. Read the "Divide Field 1 by Length" barcode, and set length to 6.
Field 1 data starts from the 1st character to the 6th character.
5. Read the "Select Field Separator to Divide Field 2" barcode, and use a dash '-' character.
Field 2 data starts from the 7th character until the dash '-' character is met.
6. Read the "Additional Field 1" barcode, and use a tab character for the field.
7. Read the "Start (Programming)" barcode to program the transmission sequence.
8. Read the "Field 2", "Additional Field 1", "Field 1", "Additional Field 1", "Field 3" barcodes.
9. Read the "End" barcode to complete the transmission sequence (F2 A1 F1 A1 F3) setting.
10. Read the "End Programming Format" barcode to complete the setting of Editing Format 1.
11. Read the "Enable Format 2" barcode to apply Editing Format 2 to all code types.
12. Read the "Update" barcode to exit the Configuration Mode.



Chapter 6

UHF RFID

The barcode scanner of 2220 model is equipped with the UHF RFID reader. Users can get data from not only barcodes but also UHF RFID tags to fulfil data collection requirements. This chapter is intended to guide users how to configure UHF RFID Reader by using command line or alternatively scanning setting barcodes.

Please refer to [Dual USB Connection](#) for correct cable connection and command/data transmission.

In This Chapter

6.1 System Information	198
6.2 Memory	200
6.3 LED Configuration	201
6.4 Beeper Configuration.....	203
6.5 Scan Mode	206
6.6 Dual Mode.....	218
6.7 USB Data Output Redirection.....	221
6.8 USB Connector B Interface Change	222
6.9 Output Data Sequence.....	223
6.10 Output Data Format	225
6.11 Format Editing for EPC.....	228



6.1 System Information

Command:

#@sys_info?\r

Purpose	Get System Information
Response	OK,[m]\r[n]\r[o]\r[p]\r
	[m]: string that indicates model name "2220E" – Basic UHF type Europe Band
	[n]: string that indicates serial number
	[o]: string that indicates kernel version
	[p]: string that indicates user version
	ERR,[code]\r

Example:

Command

#@sys_info?

Response (s)

OK,
 MODEL: 2220E → model name
 S/N: ***** → serial number
 KNL_VER: V1.00 → kernel version
 STD_VER: V1.00 → user version

6.1.1 Save User Settings as Default

For the UHF RFID/Barcode Reader to keep the customized settings as user defaults, you must issue "#@sys_svusrtbl" command.

Note: After issuing the command, the current settings will be saved as user defaults.

Command:

#@sys_svusrtbl\r

Purpose	Save User Defined Setting
Response	OK\r
	ERR,[code]\r



6.1.2 Restore User/Factory Defaults

For the UHF RFID/Barcode Reader to restore the User Defaults, which you have saved earlier, you must issue the “#@sys_ldstbl=1” command. Alternatively, you can also issue the “#@sys_ldstbl=0” command to restore Factory Default.

Command:

#@sys_ldstbl=[m]\r

Purpose	Load Default Setting
Request	#@sys_ldstbl=[m]\r [m]: `0` – Factory Default `1` – User Default
Response	OK\r ERR,[code]\r



6.2 Memory

Upon reading a tag successfully, the UHF RFID Reader responds with one short beep (high tone) and the LED indicator becomes solid green and goes off. When USB Virtual COM is not activated, the transmit buffer is used to stored scanned tags until the buffer is full.

When transmit buffer is enabled...

If USB Virtual COM is not activated, it will respond with two short beeps, high-low tone, upon reading a tag successfully.

When transmit buffer is full, the UHF RFID Reader will respond with one long beep (low tone). You are advised to check the USB Virtual COM status.

When transmit buffer is disabled...

If USB Virtual COM is not activated, it will respond with one long beep (low tone). You are advised to check the USB Virtual COM status.

Command:

#@sys_txben?\r

Purpose	Get Transmit Buffer Status
Response	OK,[m]\r ERR,[code]\r

#@sys_txben=[m] \r

Purpose	Enable Transmit Buffer [m]: `0` – Disable (default) `1` – Enable
Response	OK\r ERR,[code]\r

Alternative by scanning setting barcode

You can also choose to have the scanner read the setting barcodes below to enable/disable the transmit buffer.

Enable



104071

*Disable



104070



6.3 LED Configuration

You can configure the LED status for a feedback about good read.

6.3.1 LED Status

Command:

#@sys_leden?\r

Purpose	Get Good Read LED Status
Response	OK,[m]\r (Default m= '1')
	[m]: '0' – Disable
	'1' – Enable
	ERR,[code]\r

#@sys_leden=[m]\r

Purpose	Set LED Good Read Status
Response	OK\r
	ERR,[code]\r

Alternative by scanning setting barcode

You can also choose to have the scanner read the setting barcodes below to set the LED status for good read.

*Enable



Disable



6.3.2 LED Duration

You can configure the LED duration time.

Command:

#@sys_leddu?\r

Purpose	Get Good Read LED Duration
Response	OK,[m]\r (Default m= '4')



[m]: Duration='1' ~ '254'
ERR,[code]\r

#@sys_leddu=[m]\r

Purpose Set LED Duration

Response OK\r

ERR,[code]\r

Alternative by scanning setting barcode

You can also choose to have the scanner read the setting barcode below to set the LED duration for good read.

Good Read LED
Time-out after
0.01~2.54 sec.
(*40 ms)



- 1) Read the barcode above to specify the time interval before the Good Read LED goes off.
- 2) Read the "[Decimal Value](#)" barcode on page 253. For example, read "1" and "5" for the LED to go off after 150 milliseconds.
- 3) Read the "Validate" barcode on the same page to complete this setting.



6.4 Beeper Configuration

6.4.1 Volume

This command will change beeper volume for both barcode and UHF RFID tag reading.

Command:

`#@sys_bpvol?\r`

Purpose Get Beeper Volume
Response OK,[m]\r (Default m= 'High')

[m]: Volume

'0'	Mute
'1'	Low
'2'	Medium
'3'	High

ERR,[code]\r

`#@sys_bpvol=[m]\r`

Purpose Set Beeper Volume
Response OK\r

ERR,[code]\r

6.4.2 Frequency

By default, the frequency for a beeper is configured to 2.6 KHz. This function is available when Good-Read beep is enabled.

Command:

`#@sys_grdbf?\r`

Purpose Get Beeper Frequency
Response OK,[m]\r (Default m= '1')

[m]: Frequency

'0'	2.5 kHz
'1'	2.6 kHz
'2'	2.8 kHz
'3'	2.9 kHz

ERR,[code]\r

`#@sys_grdbf=[m]\r`



Purpose Set Beeper Frequency
 Response OK\r
 ERR,[code]\r

Alternative by scanning setting barcode

You can also choose to have the scanner read the setting barcode below to set the beeper frequency for good read.

Frequency

2.5 kHz	 104058
*2.6 kHz	 104059
2.8 kHz	 104060
2.9 kHz	 104061

6.4.3 Duration

You can configure the beeping duration to Shortest, Short, Longer or Longest. This function is available when Good-Read beep is enabled.

Command:

#@sys_grdbdu?\r

Purpose Get Beeper Duration
 Response OK,[m]\r (Default m= '0')
 [m]: Duration

'0'	Shortest
'1'	Short
'2'	Longer
'3'	Longest



ERR,[code]\r

#@sys_grdbdu=[m]\r

Purpose Set Beeper Duration

Response OK\r

ERR,[code]\r

Note: When you set the volume of beeper to mute, there will be no audio feedback.

Alternative by scanning setting barcode

You can also choose to have the scanner read the setting barcode below to set the beeper duration for good read.

Duration



6.5 Scan Mode

UHF RFID Reader scan modes include Continuous, Single, Test, and Multi-Tag modes.

Scan Mode	Description
Continuous Mode	In this mode, the UHF RFID reader is always scanning.
Single Mode	Read tags by pressing the scan button 1. Condition to start the operation: Press the scan button. 2. Condition to stop the operation: (1) A tag is read. (2) Scan button is released. (3) "Scan Session Timeout" expires while no tag data is received. (4) New scan mode is set. 3. Release the scan button and press it again to start a new operation cycle. Scanning Timeout will be refreshed.
Test Mode	Read tag continuously without pressing the scan button. Capable of decoding the same tag repeatedly for testing purposes. 1. Conditions to start the operation: Scan mode is set to "Test mode". 2. Conditions to stop the operation: New scan mode is set. 3. Scan Session Timeout, Scanning Delay, and EPC filter parameters have no effect in this mode.
Multi-Tag Mode	In this mode, the UHF RFID reader is always scanning.

Command:

#@rf_scan?\r

Purpose	Get Scan Mode
Response	OK,[m]\r (Default m= '1') [m]: Scan Mode `1` – Continuous Mode (default) `6` – Single Mode `7` – Test Mode `9` – Multi-Tag Mode ERR,[code]\r

#@rf_scan=[m]\r

Purpose	Set Scan Mode
Response	OK\r ERR,[code]\r



Alternative by scanning setting barcode

You can also choose to have the scanner read the setting barcode below to set the RFID scan mode.

Scan Mode

***Continuous**

104101

Single

104106

Testing

104107

Multi-Tag

104109



Update

6.5.1 Single Mode Timeout

You have to specify the RFID scanning timeout interval (0~254 sec.; 0= Disable) when the scan mode is set to Single Mode.

- ▶ Operation ends behind the Scan Session Timeout without receiving any tag data.
- ▶ The timeout ranges from 0 to 254 seconds. By default the value is set to '0' to disable scanning timeout.

Command:

#@rf_tscan?\r

Purpose	Get Scan Session Timeout
Response	OK,[m]\r (Default m= '0')
	[m]: Timeout, '0' ~ '254'
	ERR,[code]\r

#@rf_tscan=[m]\r

Purpose	Set Scan Section Timeout
Response	OK\r
	ERR,[code]\r

Note: This command is available for Single Mode. For example, if you set the "#@rf_tscan" value to 5, the waiting time is set to 5 seconds upon pressing the scan button. If no tag is scanned within that period, the operation stops.

Alternative by scanning setting barcode

You can also choose to have the scanner read the setting barcode below to set the RFID scanning timeout.

RFID Scanning
Timeout after 0 ~ 254
sec. (*0 sec.)



104132

- 1) Read the barcode above to specify the timeout for RFID scanning.
- 2) Read the "[Decimal Value](#)" barcode on page 253. For example, read "1" and "5" for the timeout after 15 seconds.
- 3) Read the "Validate" barcode on the same page to complete this setting.



6.5.2 Multi-Tag Mode Timeout

You can specify the time interval to prevent receiving redundant tag data when the scan mode is set to Multi-Tag Mode. During this time interval, the scanner won't accept the redundant tag data. Note when a redundant tag is scanned, the timer resets.

Command:

`#@rf_tsame?\r`

Purpose	Get redundant tag scanning timeout
Response	OK,[m]\r (Default m= '0')
	[m]: Timeout, '0' ~ '3600'
	ERR,[code]\r

`#@rf_tsame=[m]\r`

Purpose	Set redundant tag scanning timeout
Response	OK\r
	ERR,[code]\r

Alternative by scanning setting barcode

You can also choose to have the scanner read the setting barcode below to set the redundant tag scanning timeout.

Redundant RFID Tag
Scanning Timeout
after 0 ~ 3600
sec. (*0 sec.)



- 1) Read the barcode above to specify the timeout for redundant RFID tag scanning.
- 2) Read the "[Decimal Value](#)" barcode on page 253. For example, read "1" and "5" for the timeout after 15 seconds.
- 3) Read the "Validate" barcode on the same page to complete this setting.



6.5.3 Redundant Decoding (Continuous Mode)

In Continuous Mode, you can specify the time interval to prevent redundant decoding of a particular tag.

Command:

#@rf_dcodedly?\r

Purpose Get Decode Delay
 Response OK,[m]\r (Default m= '1')

[m]: Decode Delay

'0'	250ms
'1'	500ms (default)
'2'	750ms
'3'	1s
'4'	1.5s
'5'	2s
'6'	3s
'7'	4s

ERR,[code]\r

#@rf_dcodedly=[m]\r

Purpose Set Decode Delay
 Response OK\r
 ERR,[code]\r

Alternative by scanning setting barcode

You can also choose to have the scanner read the setting barcodes below to specify the time interval to prevent redundant decoding of a particular tag.

Decode Delay Time





6.5.4 Read/Write Tag Memory

By default, the UHF RFID Reader access mode is set to Inventory to get EPC of a Tag. If you want to read all data stored in a Tag, you can issue the “#@rf_func=1” command that allows you to read Reserved, EPC, TID or User bank.

RFID Function

RFID Function

Command:

#@rf_func?\r

Purpose	Get RFID Function
Response	OK,[m]\r (Default m= '0')
	[m]: RFID Function
	'0' – Inventory (default)
	'1' – Read Tag Memory
	'2' – Write Tag Memory
	ERR,[code]\r

#@rf_func=[m]\r

Purpose	Set RFID Function
Response	OK\r
	ERR,[code]\r

Alternative by scanning setting barcode

You can also choose to have the scanner read the setting barcodes below to set the access mode.

RFID Function

Write Memory



Read Memory



*Inventory



104172

Access Parameter

Index of Access Parameter

Command:

#@rf_rwidx?\r

Purpose Get Index of Access Parameter

Response OK,[m]\r

[m]: Index of Access Parameter

[m]	Meaning	Value
'0'	Access Password	'xxxxxxx' Access Password, 4 bytes, shown in Hexadecimal value. e.g. String '30313233' indicates 0x30, 0x31, 0x32, 0x33. Default= '00000000'
'1'	Memory Bank	'0' – Reserved Bank '1' – EPC '2' – TID '3' – User Bank Default= '1'
'2'	Start Byte	Only even numbers ('0', '2', '4' ... '98') are valid for the start byte. Default= '0'
'3'	Data Length Byte(s)	Only even numbers ('0', '2', '4' ... '32') are valid for data length bytes. Default= '0'

ERR,[code]

#@rf_rwidx=[m]\r

Purpose Set Index of Access Parameter

Response OK\r

ERR,[code]\r

#@rf_rwpr?\r



Purpose Get Access Parameter
Response OK,[m]\r
[m]: Access Parameter
ERR,[code]\r

#@rf_rwpr=[m]\r

Purpose Set Access Parameter
Response OK\r
ERR,[code]\r

Alternative by scanning setting barcode

You can also choose to have the scanner read the setting barcodes below to set the access parameters.

Index of Access Parameter is 0

Access Password

Password in
Hexadecimal



- 1) Read the barcode above to specify the password up to four characters in Hexadecimal.
- 2) Read the "[Hexadecimal Value](#)" barcode on page 254.
- 3) Read the "Validate" barcode on the same page to complete this setting.

Password in
Decimal



- 1) Read the barcode above to specify the password up to four characters in decimal.
- 2) Read the "[Decimal Value](#)" barcode on page 253.
- 3) Read the "Validate" barcode on the same page to complete this setting.

Index of Access Parameter is 1

Access Memory Bank

Bank 00 (Reserved)



*Bank 01 (EPC)



Bank 10 (TID)



Bank 11 (Users)



Index of Access Parameter is 2

Access Memory Start Byte

Memory Start Byte
(*0)



- 1) Read the barcode above to specify an even number ranging from 0 to 98 to be the memory start byte.
- 2) Read the "[Decimal Value](#)" barcode on page 253. For example, read "1" and "6" to be the start byte of 16.
- 3) Read the "Validate" barcode on the same page to complete this setting.

Index of Access Parameter is 3

Memory Length

Memory Length
(*0)



- 1) Read the barcode above to specify an even number ranging from 0 to 32 to be the memory length in bytes.
- 2) Read the "[Decimal Value](#)" barcode on page 253. For example, read "3" and "2" for the data length of 32 bytes.
- 3) Read the "Validate" barcode on the same page to complete this setting.

Write



In addition to specifying parameters mentioned above, you are supposed to store data into RFID reader's buffer before writing them into the tag memory.

Command:

#@rf_wbuf?\r

Purpose Get Data in Reader Buffer
Response OK,[m]\r (Default m= '0000')
 [m]: Data stored in buffer shown in hexadecimal.
 e.g. '41'=>0x41= 'A' (2 bytes NULL)
 ERR,[code]\r

#@rf_wbuf=[m]\r

Purpose Store Data into Reader Buffer
Request #@rf_wbuf=[m]\r
 [m]: Data to be stored in buffer
 Buffer size = 32 bytes
 Input data shown in hexadecimal.
 The length of data must be an even number.
 To clear the buffer, [m]= '0000'
Response OK\r
 ERR,[code]\r

Alternative by scanning setting barcode

You can also choose to have the scanner read the setting barcodes below to do the same tasks.

RFID Written Data



- 1) Read the barcode above to input data in Hexadecimal up to 32 bytes.
- 2) Read the "[Hexadecimal Value](#)" barcode on page 254.
- 3) Read the "Validate" barcode on the same page to complete this setting.



6.5.5 Adjustment for Output Power Level of the Reader

Reading distance of the Reader varies according to its output power level. Users can decrease the power level for reasons such as:

- ▶ Within the same frequency band, you may try to prevent RF interference for your own reason or to comply with the regulations.

Command:

#@rf_plv?\r

Purpose	Get the Current Output Power Level of the Reader
Response	OK,[m]\r [m]: Output power level The valid power level ranges from 0 to 12. Default value is set to 9. ERR,[code]\r

#@rf_plv=[m]\r

Purpose	Set New Output Power Level of the Reader
Request	[m]: Output power level
Response	OK\r ERR,[code]\r

Alternative by scanning setting barcode

You can also choose to have the scanner read the setting barcode below to adjust the output power level.

Output Power Level
0 ~ 12 (*9)



- 1) Read the barcode above to set the output power level.
- 2) Read the "[Decimal Value](#)" barcode on page 253. For example, read "1" and "2" to set the power level to 12.
- 3) Read the "Validate" barcode on the same page to complete this setting.



6.6 Dual Mode

The Dual Mode is defined to read barcode label and RFID tag of a particular product. With Dual Mode enabled, the barcode data is always decoded before the RFID tag while the scanner simultaneously scans tag and barcode data.

Command:

#@rf_dual?\r

Purpose	Get Dual Mode status
Response	OK,[m]\r [m]: '0' – Disable (default) '1' – Enable ERR,[code]\r

#@rf_dual=[m]\r

Purpose	Set Dual Mode status
Response	OK\r ERR,[code]\r

Alternative by scanning setting barcode

You can also choose to have the scanner read the setting barcodes below to disable/enable Dual mode.

Enable



104135

*Disable



104134



6.6.1 Dual Mode Timeout

In Dual Mode, you have to specify the RFID scanning timeout interval ranging from 1 to 254 seconds.

- ▶ The RFID scanning operation stops when the Dual Mode timeout expires without receiving any tag data.

Command:

#@rf_tdual?\r

Purpose	Get Dual Mode timeout
Response	OK,[m]\r (Default m= '5')
	[m]: Timeout, '1' ~ '254'
	ERR,[code]\r

#@rf_tdual=[m]\r

Purpose	Set Dual Mode timeout
Response	OK\r
	ERR,[code]\r

Alternative by scanning setting barcode

You can also choose to have the scanner read the setting barcode below to set the RFID scanning timeout in Dual mode.

RFID Scanning
Time-out after 1 ~
254 sec. (*5)



- 1) Read the barcode above to specify the timeout for RFID scanning in Dual mode.
- 2) Read the "[Decimal Value](#)" barcode on page 253. For example, read "1" and "5" for the timeout after 15 seconds.
- 3) Read the "Validate" barcode on the same page to complete this setting.



6.6.2 Barcode Data Retention

The barcode data is always decoded before the tag data. Users can determine to discard or keep the decoded barcode data after the expiry of the dual mode timeout.

Command:

#@rf_dtdual?\r

Purpose	Get Discard status
Response	OK,[m]\r `0` – Disable `1` – Enable (Default m= `1`) ERR,[code]\r

#@rf_dtdual=[m]\r

Purpose	Set Discard status
Response	OK\r ERR,[code]\r

Alternative by scanning setting barcode

You can also choose to have the scanner read the setting barcodes below to disable/enable barcode data retention.

*Enable



Disable



6.7 USB Data Output Redirection

By default, the scanned RFID data is output via the USB connector A only. Users can decide to have the data output via the USB connector B.

Command:

#@usb_datatoa?\r

Purpose	Get the RFID tag data output port.
Response	OK,[m]\r `0` – USB connector B `1` – USB connector A (Default) ERR,[code]\r

#@usb_datatoa=[m]\r

Purpose	Set the RFID tag data output port.
Response	OK\r ERR,[code]\r

Alternative by scanning setting barcode

You can also choose to have the scanner read the setting barcodes below to disable/enable the USB data output redirection.

*Enable



Disable



6.8 USB Connector B Interface Change

Users can change the USB connector B interface to USB COM CDC or USB HID.

Command:

#@usb_type?\r

Purpose	Get USB Interface Type
Response	OK,[m]\r (Default m='127')
	[m]: USB Type
	'127' – USB Virtual COM CDC
	'129' – USB HID
	ERR,[code]\r

#@usb_type=[m]\r

Purpose	Set USB Interface
Response	OK\r
	ERR,[code]\r

Alternative by scanning setting barcode

You can also choose to have the scanner read the setting barcodes below to toggle the USB connector B interface between USB VCOM CDC and USB HID.

USB HID



*USB VCOM CDC



Note: This function is only to swap interface of the USB connector B between USB COM CDC and USB HID. It won't change the RFID tag data output port at all.



6.9 Output Data Sequence

Define the output RFID data sequence.

Command:

#@dat_seq?\r

Purpose Get the setting of output data sequence.
Response OK,[m],[n],[o]\r (Default m='3', n='0', o='0')

[m]: Output Data Format

[m]/[n]/[o]	Section
'0'	Disable this section
'3'	EPC Tag section
'5'	Device S/N section
'6'	Barcode section (only for Dual Mode)

ERR,[code]\r

#@dat_seq=[m], [n], [o]\r

Purpose Set output data sequence

Response OK\r
ERR,[code]\r

Alternative by scanning setting barcode

You can also choose to have the scanner read the setting barcodes below to set the output data sequence.

Output Data Sequence

0 , 3, 5, 6 (*3)
for Section 1



104321

- 1) Read the barcode above to determine the output contents of section 1.
- 2) Read the "[Decimal Value](#)" barcode on page 253.
- 3) Read the "Validate" barcode on the same page to complete this setting.

0 , 3, 5, 6 (*0)
for Section 2



104322

- 1) Read the barcode above to determine the output contents of section 2.



- 2) Read the "[Decimal Value](#)" barcode on page 253.
- 3) Read the "Validate" barcode on the same page to complete this setting.

0 , 3, 5, 6 (*0)
for Section 3



104323

- 1) Read the barcode above to determine the output contents of section 3.
- 2) Read the "[Decimal Value](#)" barcode on page 253.
- 3) Read the "Validate" barcode on the same page to complete this setting.



6.10 Output Data Format

Before transmitting data which is captured by the reader, you can edit, add and re-order the sequence of the final transmitted data. There are standard formats for the specified interfaces described below.

Command:

#@dat_fmt?\r

Purpose Get Current Output Data Format

Response OK,[m]\r (Default m= '1')

[m]: Output Data Format

[m]	Description
'1'	EPC Binary (default)
'2'	Raw Data
'3'	EPC URI
'4'	EPC Tag URI

ERR,[code]\r

#@dat_fmt=[m]\r

Purpose Set New Output Data Format

Response OK\r

ERR,[code]\r

Example:

EPC Binary:

The output data consists of 16 unique symbols, the numbers 0 to 9 and the letters A to F.

Command

#@dat_fmt=1 → set output data format to EPC Binary Data

Response (s)

OK

30003430333130303132303030304221

→ EPC Binary Data



Raw Data:

Command

#@dat_fmt=2 → set output data format to Raw Data

Response (s)

OK

1. 040310012000030B! → Raw Data

EPC URI:

EPC URI is the pure identity URI form of the EPC. Take 3270AFEC2B00020000000001 in EPC hex for example, it can be presented as follows:

Command

#@dat_fmt=3 → set output data format to EPC URI

Response (s)

OK

urn:epc:id:sgln:23058518.0001.1 → EPC URI

EPC Tag URI:

EPC Tag URI resembles pure identity EPC URIs, but with added control information. Take 3270AFEC2B0002000000000001 in EPC hex for example, it can be presented as follows:

Command

#@dat_fmt=4 → set output data format to EPC Tag URI

Response (s)

OK

urn:epc:tag:sgln-96:3.23058518.0001.1 → EPC Tag URI



Alternative by scanning setting barcodes

You can also choose to have the scanner read the setting barcodes below to set EPC output data format.

EPC Data Format

***EPC Binary**

104301

Raw Data

104302

EPC URI

104303

EPC Tag URI

104304



6.11 Format Editing for EPC

The EPC tag section is divided into 5 fields as PC, EPC, CRC, Memory Data and Data Length. Separators can be defined among fields for clarity. Up to 4 separators can be specified for this section.

Default Format:

Field1	Separator1	Field2	Separator2	Field3	Separator3	Field4	Separator4	Field5	
PC	'\0' (0x00)	EPC	'\0' (0x00)	CRC	'\0' (0x00)	Memory Data	'\0' (0x00)	Disable	'\r' (0x0D)

6.11.1 Data Field Sequence

Command:

#@dat_rfseq?\r

Purpose Get the Sequence Setting of EPC Tag Data Section

Response OK,[m],[n],[o],[p],[q]\r

[m]: EPC Tag Data in Field 1 (default: '2' – PC)

[n]: EPC Tag Data in Field 2 (default: '3' – EPC)

[o]: EPC Tag Data in Field 3 (default: '1' – CRC)

[p]: EPC Tag Data in Field 4 (default: '4' – Memory Data)

[q]: EPC Tag Data in Field 5 (default: '0' – Disable)

[m]~[q]	Description
'0'	Disable this Field
'1'	CRC
'2'	PC
'3'	EPC
'4'	Memory Data This field only appears when RFID function is set to "Read Tag Memory"
'5'	Data Length

ERR,[code]\r

#@dat_rfseq=[m],[n],[o],[p],[q]\r

Purpose Set the Sequence of Each Field in EPC Tag Data Section



Response OK\r
ERR,[code]\r

Example:**Command**

#@rf_func? → get RFID function
Default is inventory

Response (s)

OK,0
30003430333130303132303030304221

Command

#@dat_rfseq? → get the sequence of RFID Data
Default sequence is PC, EPC and then CRC

Response (s)

OK,2,3,1,4,0
3000 343033313030313230303030 4221
PC + EPC + CRC

Command

#@dat_rfseq=3,0,0,0,0 → only show EPC

Response (s)

OK
343033313030313230303030
EPC

Alternative by scanning setting barcode

You can also choose to have the scanner read the setting barcodes below to set data sequence of the EPC Tag Section.

Data Sequence of EPC Tag Section

0 ~ 5 (*2)
for Field 1



Update

- 1) Read the barcode above to determine the output contents of field 1.
- 2) Read the "[Decimal Value](#)" barcode on page 253.
- 3) Read the "Validate" barcode on the same page to complete this setting.

0 ~ 5 (*3)
for Field 2



- 1) Read the barcode above to determine the output contents of field 2.
- 2) Read the "[Decimal Value](#)" barcode on page 253.
- 3) Read the "Validate" barcode on the same page to complete this setting.

0 ~ 5 (*1)
for Field 3



- 1) Read the barcode above to determine the output contents of field 3.
- 2) Read the "[Decimal Value](#)" barcode on page 253.
- 3) Read the "Validate" barcode on the same page to complete this setting.

0 ~ 5 (*4)
for Field 4



- 1) Read the barcode above to determine the output contents of field 4.
- 2) Read the "[Decimal Value](#)" barcode on page 253.
- 3) Read the "Validate" barcode on the same page to complete this setting.

0 ~ 5 (*0)
for Field 5



- 1) Read the barcode above to determine the output contents of field 5.
- 2) Read the "[Decimal Value](#)" barcode on page 253.
- 3) Read the "Validate" barcode on the same page to complete this setting.



6.11.2 Data Separator

The separator to be configured or retrieved can present in ASCII characters or hexadecimal numbers.

Command:

#@dat_rfsprh?\r, #@dat_rfspr?\r

Purpose	Get the Separators of Each field in EPC Tag Data Section
Request	#@dat_rfsprh?\r Response data will be shown in Hexadecimal value #@dat_rfspr?\r Response data will be shown in character
Response	OK,[m],[n],[o],[p]\r [m]: separator follows field1. Default= '00' (NULL) [n]: separator follows field2. Default= '00' (NULL) [o]: separator follows field3. Default= '00' (NULL) [p]: separator follows field4. Default= '00' (NULL) ERR,[code]\r

#@dat_rfspr=[m],[n],[o],[p],[q]\r

Purpose	Set the Separators of Each field in EPC Tag Data Section
Request	#@dat_rfspr=[m],[n],[o],[p],[q]\r [m]: input data format, '0'- in Hexadecimal, '1'- in character [n]: separator between field1 and field2 [o]: separator between field2 and field3 [p]: separator between field3 and field4 [q]: separator between field4 and field5
Response	OK\r ERR,[code]\r

Note: Input '00' (hexadecimal) to clear the inputted data.

Example:

Command

#@dat_rfspr? → get the separators in character format

Response (s)

OK,

Command

#@dat_rfsprh? → get the separators in hexadecimal format



Response (s)

OK,00,00,00,00

34303331303031323030303030004221

Command

#@dat_rfsprh=0,2d,2d,2d,2d

→ reset the separators using hexadecimal format
e.g. 2d is specified for `-'`

Response (s)

OK

343033313030313230303030-3000-4221-

Command

#@dat_rfsprh=1,/,,/,/,/

→ reset the separators using character format

Response (s)

OK

343033313030313230303030/3000/4221/

Note: If a specific field is disabled, its following separator will be ignored.

Alternative by scanning setting barcode

You can also choose to have the scanner read the setting barcodes below to specify the separators between fields.

Separator

Separator after
Field 1



104329

- 1) Read the barcode above to specify the separator which follows field 1.
- 2) Read the "[Hexadecimal Value](#)" barcode on page 254.
- 3) Read the "Validate" barcode on the same page to complete this setting.

Separator after
Field 2



104330

- 1) Read the barcode above to specify the separator which follows field 2.
- 2) Read the "[Hexadecimal Value](#)" barcode on page 254.
- 3) Read the "Validate" barcode on the same page to complete this setting.



Separator after
Field 3



104331

- 1) Read the barcode above to specify the separator which follows field 3.
- 2) Read the "[Hexadecimal Value](#)" barcode on page 254.
- 3) Read the "Validate" barcode on the same page to complete this setting.

Separator after
Field 4



104332

- 1) Read the barcode above to specify the separator which follows field 4.
- 2) Read the "[Hexadecimal Value](#)" barcode on page 254.
- 3) Read the "Validate" barcode on the same page to complete this setting.



6.11.3 Data Length

Enable the Data Length function to show the length for UHF Data, EPC and memory data.

Command:

#@dat_rflen?\r

Purpose	Get the Setting of UHF Data Length
Response	OK,[m]\r (Default m= '0')
	[m]: Data Length Type
	'0'- Total UHF Data Length. Separators are not included.
	'1'- EPC Length
	'2'- Memory Data Length
	ERR,[code]\r

Note: UHF data length is not related to the appearance of fields. For example, when the field is set to display EPC data only with data length set to "Total UHF Data Length", data length will include PC and CRC data even though the two data fields are not displayed.

#@dat_rflen=[m]\r

Purpose	Set the RFID Data Length
Response	OK\r
	ERR,[code]\r

Example:

Command

#@dat_rfseq? → get the sequence of RFID data

Response (s)

OK,2,3,1,4,0 → default data length is '0' not transmitted
34303331303031323030303030004221_

Command

#@dat_rfseq=2,3,1,4,5 → set to '5' to display data length

Response (s)

OK,2,3,1,4,5
3430333130303132303030303000422116
→ total data length is 16 bytes including PC (2 bytes), EPC (12 bytes), and (CRC 2 bytes)



Command

#@dat_rflen? → get the RFID data length setting

Response (s)

OK,0

3430333130303132303030303000422116

→ display total data length

Command

#@dat_rflen=1 → change the value to 1 displaying the EPC length only

Response (s)

OK,2,3,1,4,5

3000343033313030313230303030422112

→ EPC data length is 12 bytes

Command

#@dat_rflen=2 → change the value to 2 displaying the Memory data length only

Response (s)

OK

300034303331303031323030303042210

→ fail to read the Tag Memory data so the data length is 0

Alternative by scanning setting barcode

You can also choose to have the scanner read the setting barcodes below to specify the data length.

Data Length

*Total Length



104335

EPC Length



104336



Memory Data Length



104337



Enter Setup

Specifications

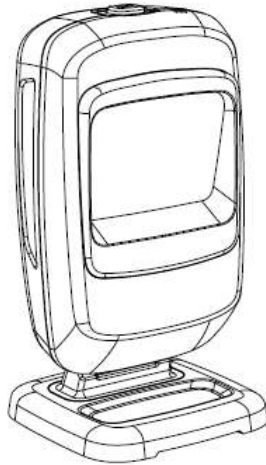

Optical Characteristics	2200	2210	2220
Scan Engine	2D Imager	2D Imager w/ EAS	2D Imager w/ UHF RFID
Optical Sensor	CMOS Image Sensor 1280 x 800 pixels		
Light Source	Aiming pattern: 520~532nm LED Illumination: 616~625nm LED		
Resolution	1D: 3mil PDF417: 5mil 2D: 7mil		
Depth of Field	Code 39 3 mil: 0 to 5 cm QR Code 7 mil: 0.5 to 2.5 cm EAN13 13mil: 0 to 20 cm PDF417 5mil: 1 to 6 cm		
Pitch Angle	± 70° (20mil)		
Skew Angle	± 75° (20mil)		
Print Contrast (Minimum)	25%		
Ambient Illumination	100,000 Lux		



UHF RFID				
Frequency Range				North America: 902 - 928 MHz; Europe: 865 - 868 MHz; Taiwan: 922 ~ 928MHz; China: 920 ~ 925MHz; Korea: 917.3 ~ 920.3MHz; New Zealand: 920 ~ 928MHz; Australia: 918 ~ 926MHz;
Supported Tag Type				ISO 18000-6C, EPCglobal Class1 Gen2 (Standard), EPCglobal Class1 Gen2V2 (Standard)
Options				
EAS			Compatible with Checkpoint deactivation systems of 8.2 MHz	
Physical Characteristics				
Indication		Tri-color LED (Red/Green/Blue) and beeper		
Interface Options		Keyboard Wedge, RS-232, USB HID, USB Virtual COM		
Weight		320g	320g	380g
Dimensions (L x W x H)		80 x 80 x 150 mm		
Electrical Characteristics				
Input Voltage		5V@2A Max.		
Power Consumption	Standby	300mA	300mA	350mA
	Operating	450mA	450mA	1A
Environmental Characteristics				



Temperature	Operating	0 °C to 40 °C
	Storage	-40 °C to 60 °C
Humidity (Non-condensing)	Operating	10% to 90%
	Storage	5% to 95%
Resistance		
Impact Resistance	1.5 m (4.9 ft) multiple drops onto concrete	
Splash / Dust Resistance	IP 52	
Electrostatic Discharge	± 15 kV air discharge, ± 8 kV contact discharge	
Programming Support		
Configuration via Setup Barcodes	Use setup barcodes or host serial commands.	
Programmable Features	Data editing, interface selection, symbology configuration	
Software	Windows®-based ScanMaster; Web-based ScanMaster	
Firmware Upgradeable	Download firmware updates via the download utility.	
Accessories (√ means “supported”)		
Keyboard Wedge Cable	√	
RS-232 Cable	√	
USB Cable	√	
Dual-USB Cable	√	
Locking Mount Bracket	√	





Firmware Upgrade

Using RS-232

- 1) Connect the RS-232 cable between the scanner and the computer, and join the power supply cord.
- 2) Read the following barcodes in sequence to configure the scanner to use RS-232 as download interface.

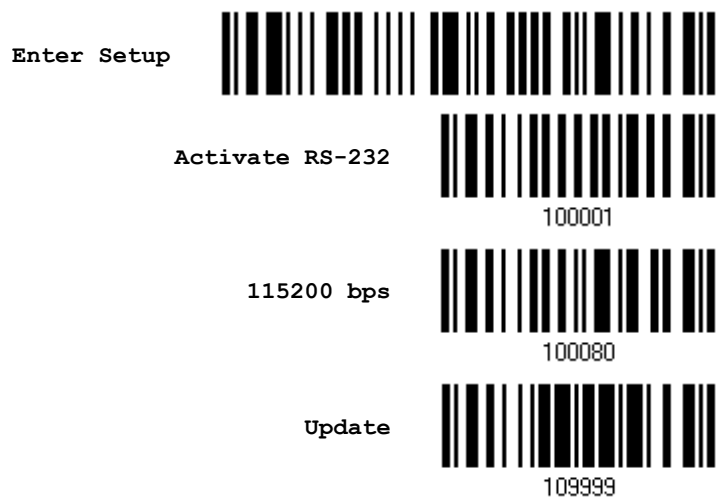

- 3) Read the following barcodes in sequence for the scanner to enter the download mode. The scanner will respond with beeps to indicate it is ready for downloading.



4) Run the download utility "ProgLoad.exe" on the computer.

Kernel Program	User Program
2200_CPU_K_*.shx	2200_CPU_S_*.shx

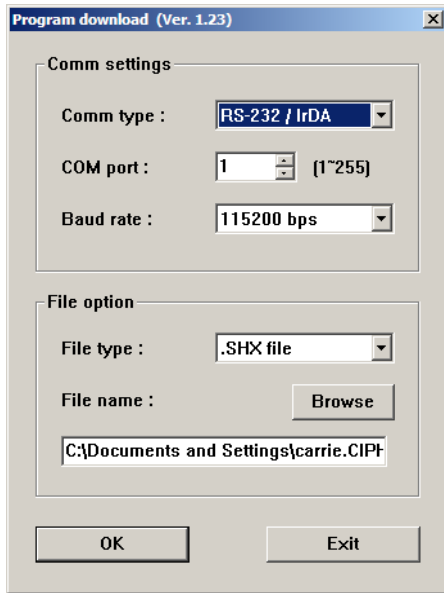

- ▶ For the communication settings, select "RS-232" and the correct COM port for RS-232 or USB Virtual COM interface.
- ▶ For RS-232, select 115200 bps for baud rate; for USB Virtual COM, ignore the baud rate setting.
- ▶ For the file option, click [Browse] to select the target file for firmware update.
- ▶ Click [OK].

5) After upgrading kernel or user program with success, the scanner will automatically restart itself.

Note: The output interface remains unchanged as specified in step 2 (= RS-232 or USB Virtual COM). For RS-232, the baud rate setting is still 115200 bps!



Using USB Virtual COM

- 1) Connect the USB cable between the scanner and the computer.
 - ▶ If using USB Virtual COM for the first time, you must install its driver beforehand.
- 2) For Windows platform, read the following barcodes in sequence to configure the scanner to use USB VCOM_CDC as download interface.

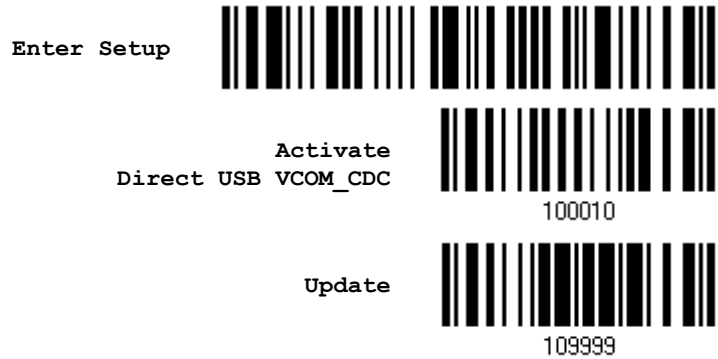

For non-Windows platform, read the following barcodes in sequence to configure the scanner to use USB Virtual COM as download interface.

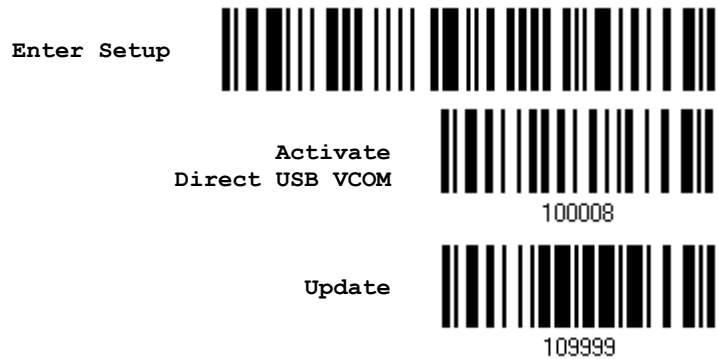

- 3) Read the following barcodes in sequence for the scanner to enter the download mode. The scanner will respond with beeps to indicate it is ready for downloading.



- 4) Run the download utility "ProgLoad.exe" on the computer.



Kernel Program	User Program
2200_CPU_S_*.shx	2200_CPU_S_*.shx

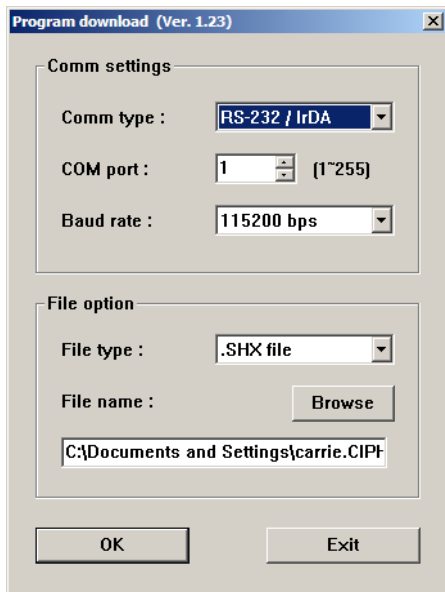

- ▶ For the communication settings, select "RS-232" and the correct COM port for RS-232 or USB Virtual COM interface.
- ▶ For RS-232, select 115200 bps for baud rate; for USB Virtual COM, ignore the baud rate setting.
- ▶ For the file option, click [Browse] to select the target file for firmware update.
- ▶ Click [OK].

5) After upgrading kernel and user program, the scanner will automatically restart itself once the download is completed successfully.

Note: The output interface remains unchanged as specified in step 2 (= RS-232 or USB Virtual COM). For RS-232, the baud rate setting is still 115200 bps!



Host Serial Commands

Serial Commands

D

Purpose To disable the scanner.
Remarks "D"

E

Purpose To enable the scanner.
Remarks "E"

#@ nnnnnn <CR>

Purpose To configure the scanner.
Remarks nnnnnn – the six digits of command parameters.
For example, "109952" is to list the current Code ID settings.

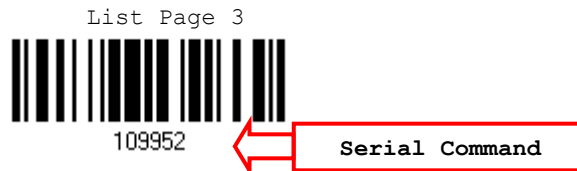

"0x23" + "0x40" + "0x31" + "0x30" + "0x39" + "0x39" + "0x35" + "0x32" + "0x0d"

Note: After configuring the scanner, send the serial command "#@109999" to save the settings.

#@ ----<CR>

Purpose To halt the scanner.
Remarks "0x23" + "0x40" + "0x2d" + "0x2d" + "0x2d" + "0x2d" + "0x0d"

#@<CR>

Purpose To resume operation.
Remarks "0x23" + "0x40" + "0x2e" + "0x2e" + "0x2e" + "0x2e" + "0x0d"

#@////<CR>

Purpose To respond with a beep.
Remarks "0x23" + "0x40" + "0x2f" + "0x2f" + "0x2f" + "0x2f" + "0x0d"



#@TRIGOFF<CR>

Purpose Disable software trigger

Remarks "0x23" + "0x40" + "0x54" + "0x52" + "0x49" + "0x47" + "0x4f" + "0x46" + "0x46"
+ "0x0d"

#@TRIGON<CR>

Purpose Enable software trigger

Remarks "0x23" + "0x40" + "0x54" + "0x52" + "0x49" + "0x47" + "0x4f" + "0x4e" + "0x0d"

Example

Run HyperTerminal.exe on the host computer to send serial commands to the scanner via RS-232 or USB Virtual COM.

- ▶ For the scanner to stop immediately –

D

- ▶ For the scanner to resume working –

E

- ▶ For the scanner to change the beeper to medium volume and beep –

#@101011<CR>

#@////<CR>

- ▶ For the scanner to change the beeper to minimal volume and beep –

#@101010<CR>

#@////<CR>

- ▶ For the scanner to change the beeper frequency to 8 kHz (for Good Read Beep only) and beep –

#@101001<CR>

#@////<CR>

- ▶ For the scanner to change the beeper length to longest (for Good Read Beep only) and beep –

#@101008<CR>

#@////<CR>

- ▶ For the scanner to save the settings, send the serial command "#@109999" –

#@101011<CR>

#@109999<CR>

Note: Configure more than one scanner connected to the host via RS-232 or USB Virtual COM. To identify the scanner, please end the serial command to have it respond with a beep.



Keyboard Wedge Table

Special Keyboard: Bypass

Characters listed in the table below are applied to the scanner by default (the Bypass special keyboard).

	0	1	2	3	4	5	6	7	8
0			SP	0	@	P	`	p	
1			!	1	A	Q	a	q	
2			"	2	B	R	b	r	
3			#	3	C	S	c	s	
4			\$	4	D	T	d	t	
5			%	5	E	U	e	u	
6			&	6	F	V	f	v	
7			'	7	G	W	g	w	
8	BS		(8	H	X	h	x	
9	HT)	9	I	Y	i	y	
A	LF		*	:	J	Z	j	z	
B		ESC	+	;	K	[k	{	
C			,	<	L	\	l		
D	CR		-	=	M]	m	}	
E			.	>	N	^	n	~	
F			/	?	O	_	o	Dly	



Special Keyboard: Apply

When the special keyboard is set to "Apply", characters listed in the table below are applied to the scanner.

	0	1	2	3	4	5	6	7	8
0		F2	SP	0	@	P	`	p	⓪
1	INS	F3	!	1	A	Q	a	q	①
2	DLT	F4	"	2	B	R	b	r	②
3	Home	F5	#	3	C	S	c	s	③
4	End	F6	\$	4	D	T	d	t	④
5	Up	F7	%	5	E	U	e	u	⑤
6	Down	F8	&	6	F	V	f	v	⑥
7	Left	F9	'	7	G	W	g	w	⑦
8	BS	F10	(8	H	X	h	x	⑧
9	HT	F11)	9	I	Y	i	y	⑨
A	LF	F12	*	:	J	Z	j	z	
B	Right	ESC	+	;	K	[k	{	
C	PgUp	Exec	,	<	L	\	l		
D	CR	CR*	-	=	M]	m	}	
E	PgDn		.	>	N	^	n	~	
F	F1		/	?	O	_	o	Dly	ENTER*

Note: (1) ⓪~⑨: Digits on the numeric keypad.
 (2) CR*/ENTER*: ENTER key on the numeric keypad.



Special Keyboard: Bypass with Control Character Output for Windows

When the special keyboard is set to "Bypass with Control Character Output for Windows", characters listed in the table below are applied to the scanner.

	0	1	2	3	4	5	6	7	8
0		DLE	SP	0	@	P	`	p	
1	SOH	DC1	!	1	A	Q	a	q	
2	STX	DC2	"	2	B	R	b	r	
3	ETX	DC3	#	3	C	S	c	s	
4	EOT	DC4	\$	4	D	T	d	t	
5	ENQ	NAK	%	5	E	U	e	u	
6	ACK	SYN	&	6	F	V	f	v	
7	BEL	ETB	'	7	G	W	g	w	
8	BS	CAN	(8	H	X	h	x	
9	HT	EM)	9	I	Y	i	y	
A	LF	SUB	*	:	J	Z	j	z	
B	VT	ESC	+	;	K	[k	{	
C	FF	FS	,	<	L	\	l		
D	CR	GS	-	=	M]	m	}	
E	SO	RS	.	>	N	^	n	~	
F	SI	US	/	?	O	_	o	Dly	



Key Type & Status

Key Type

If “Keyboard Wedge” or “USB HID” is configured for interface, Key Type and Key Status will then become applicable.

*Normal



109926

Scan Code



109936

Key Status

Decide whether or not to change key status when “Normal Key” is selected for Key Type.

Add Shift



109930

Add Left Ctrl



109931

Add Right Ctrl



109933

Add Left Alt



109932

Add Right Alt



109934



Example

KEY TYPE = NORMAL

For example, if you want to program the character “!” as the prefix code:

1. Read the “Configure Prefix” barcode.
2. Read the “[Hexadecimal Value](#)” barcode on page 254 for “2” and “1”.
3. Read the “Validate” barcode to complete this setting.

KEY TYPE = SCAN CODE

For example, if you want to program the character “a” (= “1C” on the scan code table) as the prefix code:

1. Read the “Configure Prefix” barcode.
2. Read the “Scan Code” barcode.
3. Read the “[Hexadecimal Value](#)” barcode on page 254 for “1” and “C”.
4. Read the “Validate” barcode to complete this setting.

KEY TYPE = NORMAL + KEY STATUS = SHIFT

For example, if you want to program the character “!” (= “Shift” + “1” on keyboard) as the prefix code:

1. Read the “Configure Prefix” barcode.
2. Read the “Add Shift” barcode.
3. Read the “[Hexadecimal Value](#)” barcode on page 254 for “3” and “1”.
4. Read the “Validate” barcode to complete this setting.

KEY TYPE = NORMAL + KEY STATUS = CTRL

For example, if you want to program “Ctrl+A” and “Ctrl+\$” as the prefix code:

1. Read the “Configure Prefix” barcode.
2. Read the “Add Left Ctrl” barcode.
3. Read the “[Hexadecimal Value](#)” barcode on page 254 for “4”, “1” (= “A”).
4. Read the “Add Left Ctrl” barcode.
5. Read the “[Hexadecimal Value](#)” barcode on page 254 for “2”, “4” (= “\$”).
6. Read the “Validate” barcode to complete this setting.





Numeral Systems

Decimal System

Decimal



Validate the Values



Hexadecimal System

Hexadecimal



Validate the Values



ASCII Table

	0	1	2	3	4	5	6	7	
0		DLE	SP	0	@	P	`	p	
1	SOH	DC1	!	1	A	Q	a	q	
2	STX	DC2	"	2	B	R	b	r	
3	ETX	DC3	#	3	C	S	c	s	
4	EOT	DC4	\$	4	D	T	d	t	
5	ENQ	NAK	%	5	E	U	e	u	
6	ACK	SYN	&	6	F	V	f	v	
7	BEL	ETB	'	7	G	W	g	w	
8	BS	CAN	(8	H	X	h	x	
9	HT	EM)	9	I	Y	i	y	
A	LF	SUB	*	:	J	Z	j	z	
B	VT	ESC	+	;	K	[k	{	
C	FF	FS	,	<	L	\	l		
D	CR	GS	-	=	M]	m	}	
E	SO	RS	.	>	N	^	n	~	
F	SI	US	/	?	O	_	o	DEL	

Update



Abort





Reading Driver Licenses

The scanner is capable of reading 2D driver's licenses and other American Association of Motor Vehicle Administrators (AAMVA) compliant ID cards. For compliant 2D licensed card scanning, it decodes the information embedded in the ID cards to a formatted data. This appendix provides the setup barcodes required while ScanMaster utility provides GUI setup that is organized and easy-to-use.

Note: The configured settings are saved in flash memory for access once a driver's license is read.

License Parsing Setup

*License Parse Disable



103000

License Parse Enable



103001

Parse Field Clear



103002

File Type

You can check the file type of ANSI by scanning the barcode as below.

*Enable



103004

Disable



103003

Update













Abort















Output Sequence Setup

The scanner supports arranging the sequences of license embedded data via separators and fields. In order to present data in a consistent format, some barcodes (ex. First Name, Middle Name/Initial, Last Name, Name suffix, Name Prefix, Birth Date and so on) will return data based on the calculated actual data contained in the ID barcode.

Full Name	 103011
Last Name	 103012
First Name	 103013
Middle Name/Initial	 103014
Name Suffix	 103015
Name Prefix	 103016
Mailing Address Line1	 103017
Mailing Address Line2	 103018
Mailing Address City	 103019
Mailing Address State	 103020



<p>Mailing Address Postal Code</p>	 103021
<p>Home Address Line1</p>	 103022
<p>Home Address Line2</p>	 103023
<p>Home Address City</p>	 103024
<p>Home Address State</p>	 103025
<p>Home Address Postal Code</p>	 103026
<p>License ID Number</p>	 103027
<p>License Class</p>	 103028
<p>License Restrictions</p>	 103029
<p>License Endorsements</p>	 103030
<p>Height (Feet and/or Inches)</p>	 103031
<p>Height (Centimeters)</p>	 103032

Update











Abort



Weight (Pounds)	 103033
Weight (Kilograms)	 103034
Eye Color	 103035
Hair Color	 103036
License Expiration Date	 103037
Birth Date	 103038
Gender	 103039
License Issue Date	 103040
Issue Timestamp	 103041
Number of Duplicates	 103042
Medical Codes	 103043
Organ Donor	 103044















Nonresident	 103045
Customer ID	 103046
Social Security Number	 103047
AKA Birth Date	 103048
AKA Social Security Name	 103049
AKA Full Name	 103050
AKA Last Name	 103051
AKA First Name	 103052
AKA Middle Name/Initial	 103053
AKA Name Suffix	 103054
AKA Name Prefix	 103055
Weight Range	 103056

Update



Abort



Document Discriminator	 103057
Country	 103058
Federal Commission Codes	 103059
Place of Birth	 103060
Audit Information	 103061
Inventory Control	 103062
Race/Ethnicity	 103063
Std Vehicle Class	 103064
Std Restrictions	 103065
Std Endorsements	 103066
Class Description	 103067
Endorsement Description	 103068



Restrictions
Description



103069

Permit Class



103070

Permit Expiration
Date



103071

Permit ID Number



103072

Permit Issue Date



103073

Permit Restrictions



103074

Permit endorsements



103075

Issuer ID Number



103076

Family Name
Truncation



103077

First Name
Truncation



103078

Middle Name
Truncation



103079

Update













Abort



Separators and Fields

Define the separators that separate fields during the transmission sequence of data scanning. In addition to the built-in data elements, you can also specify up to 5 Additional Fields with 4 bytes characters. Program the transmission sequence by reading the desired fields as additional fields.

Note: Up to 5 separators can be assigned.

Separator 1 (1 byte) *"Space"	
	103128
Separator 2 (1 byte) *"Enter"	
	103129
Separator 3 (1 byte) *","	
	103130
Separator 4 (1 byte) *","	
	103131
Separator 5 (1 byte) *"-"	
	103132
Additional Field 1 (4 bytes)	
	103133
Additional Field 2 (4 bytes)	
	103134
Additional Field 3 (4 bytes)	
	103135
Additional Field 4 (4 bytes)	
	103136
Additional Field 5 (4 bytes)	
	103137



Edit Separators

All the driver license fields can be split with a pre-selected separator, for example, "-" as First Name-Last Name or ":" as First Name:Last Name.

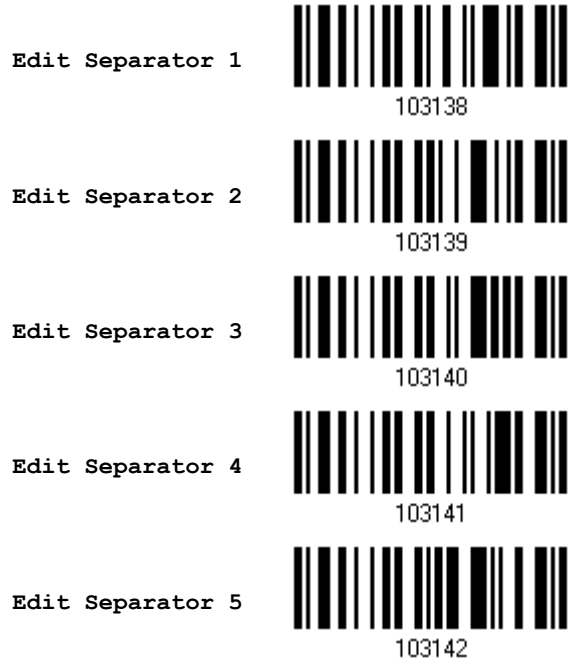

- 1) Read the barcode above to apply separator to driver license information separately, and follow steps 2~3.
- 2) Read the "[Hexadecimal Value](#)" barcode for the desired character string. For example, read "3" and "A" for the separator to split the data with character [:].
- 3) Read the "Validate" barcode on the same page to complete this setting.

Update



Abort



Edit Fields

Up to five additional fields can be created for each editing format; each of them is numbered from Additional 1 to Additional 5 accordingly.

- ▶ If “Bluetooth® HID” or “USB HID” is configured for interface, Key Type and Key Status will then become applicable. You may decide whether or not to apply Key Status when “Normal Key” is selected for Key Type.

Key Type		Key Status
Scan Code	Up to 2 scan code values are allowed.	N/A
Normal Key	Up to 4 character strings are allowed.	<ul style="list-style-type: none"> ▶ Add Shift ▶ Add Left Ctrl ▶ Add Left Alt ▶ Add Right Ctrl ▶ Add Right Alt Refer to Keyboard Wedge Table .

Edit Additional Field 1



103143

Edit Additional Field 2



103144

Edit Additional Field 3



103145

Edit Additional Field 4



103146

Edit Additional Field 5



103147

- 1) Read the barcode above to specify an additional field, one at a time.
- 2) Read the “[Hexadecimal Value](#)” barcode for the desired additional field.
- 3) Read the “Validate” barcode on the same page to complete this setting.



Appendix VI

Keyboard Type One-Scan Barcode

Keyboard Wedge

PCAT (US)



#@KW0001#

PCAT (French)



#@KW0002#

PCAT (German)



#@KW0003#

PCAT (Italian)



#@KW0004#

PCAT (Swedish)



#@KW0005#

PCAT (Norwegian)



#@KW0006#

PCAT (UK)



#@KW0007#

PCAT (Belgium)



#@KW0008#

PCAT (Spanish)



#@KW0009#

PCAT (Portuguese)



#@KW0010#

PS55 A01-1



#@KW0011#

PS55 A01-2 (Japanese)



#@KW0012#

PS55 A01-3



#@KW0013#

PS55 001-1



#@KW0014#

PS55 001-81



#@KW0015#

PS55 001-2



#@KW0016#

PS55 001-82



#@KW0017#

PS55 001-3



#@Kw0018#

PS55 001-8A



#@Kw0019#

PS55 002-1, 003-1



#@Kw0020#

PS55 002-81, 003-81



#@Kw0021#

PS55 002-2, 003-2



#@Kw0022#

PS55 002-82, 003-82



#@Kw0023#

PS55 002-3, 003-3



#@Kw0024#

PS55 002-8A, 003-8A



#@Kw0025#

IBM 3477 Type 4 (Japanese)



#@Kw0026#

PS2-30



#@KW0027#

IBM 34XX/319X, Memorex Telex 122 Keys



#@KW0028#

User-defined table



#@KW0029#

PCAT (Turkish)



#@KW0030#

PCAT (Hungarian)



#@KW0031#

PCAT (Swiss German)



#@KW0032#

PCAT (Danish)



#@KW0033#

PCAT (Greek)



#@KW0035#

PCAT (Russian)



#@KW0037#

PCAT (Cyrillic on Russian)



#@Kw0042#

PCAT (Armenian)



#@Kw0043#

PCAT (Thai)



#@Kw0044#

PCAT (Slovenian)



#@Kw0045#

PCAT (Mexican Spanish)



#@Kw0046#

PCAT (Traditional Chinese)



#@Kw0047#

PCAT (Swiss French)



#@Kw0048#

PCAT (Czech)



#@Kw0049#

Direct USB HID

PCAT (US)



#@DH0064#

PCAT (French)



#@DH0065#

PCAT (German)



#@DH0066#

PCAT (Italian)



#@DH0067#

PCAT (Swedish)



#@DH0068#

PCAT (Norwegian)



#@DH0069#

PCAT (UK)



#@DH0070#

PCAT (Belgium)



#@DH0071#

PCAT (Spanish)



#@DH0072#

PCAT (Portuguese)



#@DH0073#

PS55 A01-2 (Japanese)



#@DH0074#

User-defined table



#@DH0075#

PCAT (Turkish)



#@DH0076#

PCAT (Hungarian)



#@DH0077#

PCAT (Swiss German)



#@DH0078#

PCAT (Danish)



#@DH0079#

PCAT (Greek)



#@DH0081#

PCAT (Russian)



#@DH0083#

PCAT (Cyrillic on Russian)



#@DH0088#

PCAT (Armenian)



#@DH0089#

PCAT (Thai)



#@DH0090#

PCAT (Slovenian)



#@DH0091#

PCAT (Mexican Spanish)



#@DH0092#

PCAT (Traditional Chinese)



#@DH0093#

PCAT (Swiss French)



#@DH0094#

PCAT (Czech)



#@DH0095#

Appendix VII

Status code

value	Meaning
0xEF	RFID Fail (Unable to configure RFID module with specified Module Power Level.)
0xFD	Invalid parameter in the Data field
0xFF	Invalid command or parameters

Update



Abort

